

Jordi & Jamil **Instruments**

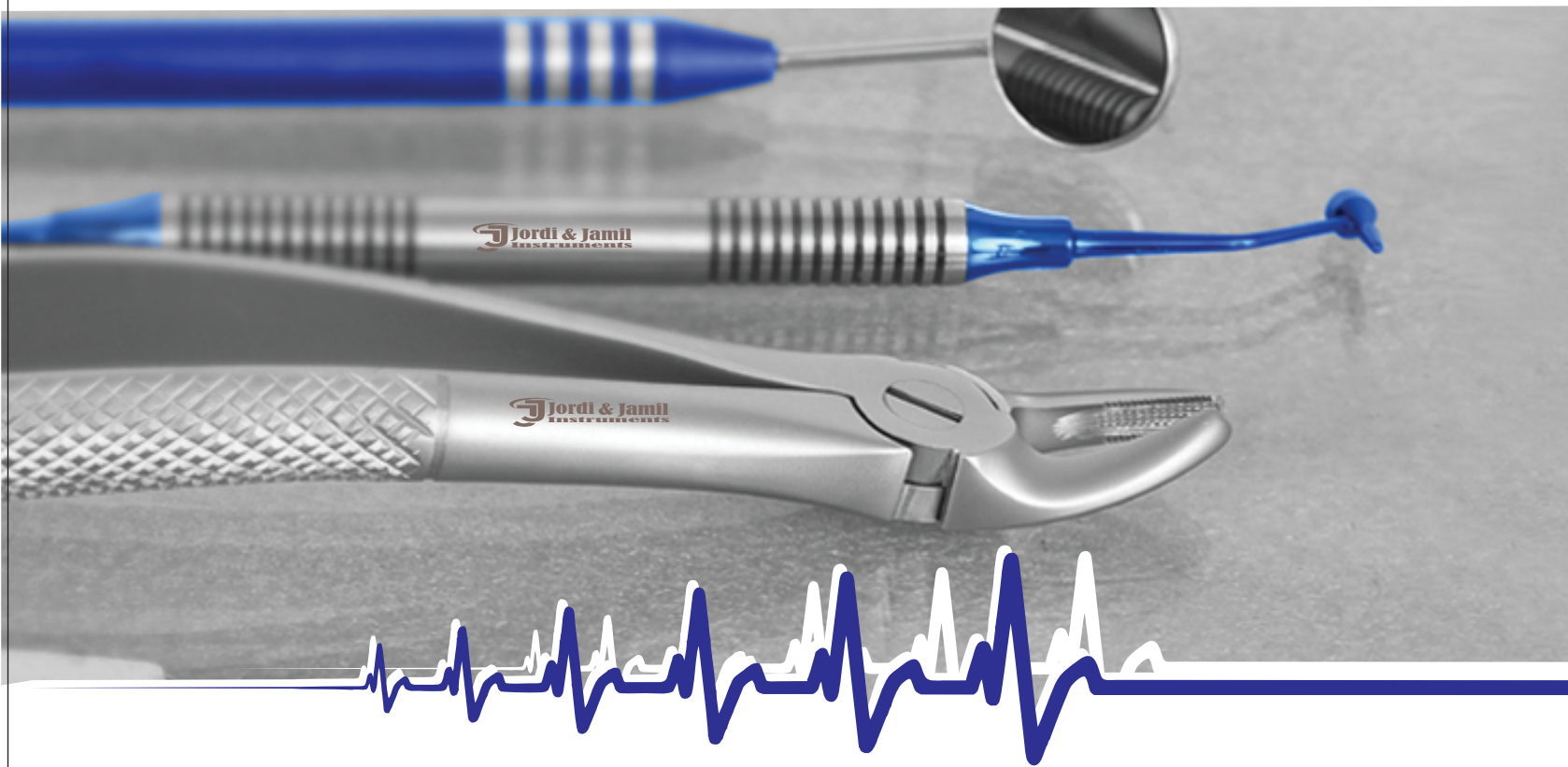

DENTAL instruments
Catalogue

Company Profile

We at **JORDI & JAMIL** welcome you to the world of reliable quality in the products where it matters the most, to the world of precision, where lack of it could be a matter of life and death.

JORDI & JAMIL is an industry leader in manufacturing and providing worldwide solutions for SURGICAL / DENTAL / DIAGNOSTIC & HOLLOW WARE instruments.

Our Professionals continually strive to satisfy your technical and clinical needs of surgical instruments. We maintain a team work environment throughout the company by placing experienced members on critical manufacturing processes in instrument craftsmanship with state-of-the-art precision manufacturing equipments and the latest technologies to achieve the highest possible results.

Our instruments range from precision micro handheld surgical instruments(including forceps, clamps, scissors, needle holders, cutting and clamping devices) used in general surgery, ophthalmic, neurosurgical, ENT and cardiovascular specialties to macro instruments used in spinal, orthopedic and other surgical areas.

JORDI & JAMIL holds worldwide recognized certifications such as:

Which ensures our clientage that they are in best hands when it comes to quality of the instruments as well as their compliance with the international standards.

Our Quality policy ensures that every instrument is manufactured to its highest quality by maintaining quality checks at every stage, as it is our belief that our success depends on establishing enduring relationships with our customers and consistently producing high quality products that meet their demanding standards and timetables.



Production View



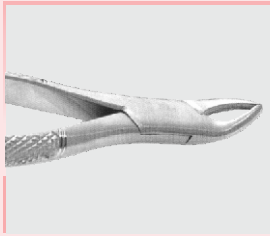

01

Extracting Forceps

Page 01-31

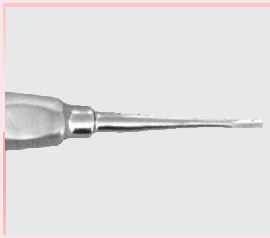

02

Root Elevators

Page 32-50

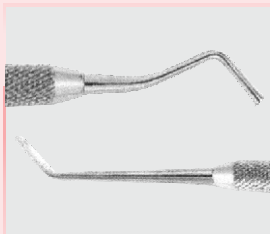

03

Filling Instruments

Page 51-55

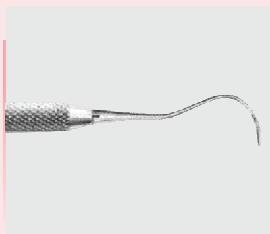

04

Dental Probes

Page 56-59

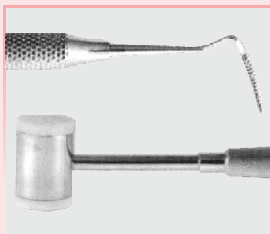

05

Periodontia Instruments
Mallets

Page 60-67

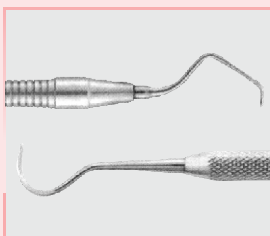

06

Curettes
Scalers

Page 68-74

TABLE OF CONTENTS

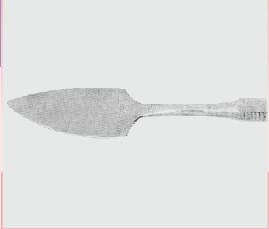
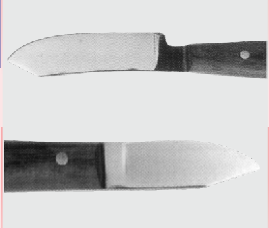
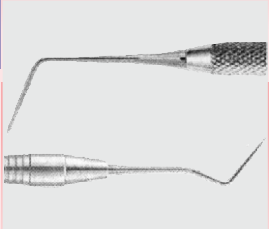
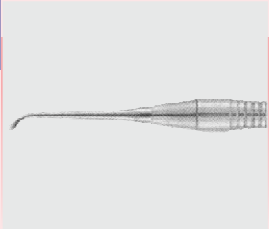
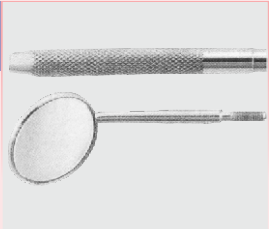
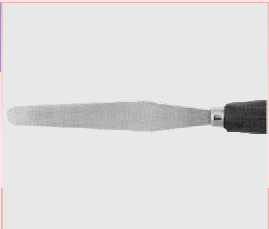
<p>Page 75-77</p> <p>Modelling Instruments Measuring Instruments</p>	<p>07</p> 
<p>Page 78-79</p> <p>Wax / Plaster Knives</p>	<p>08</p> 
<p>Page 80-85</p> <p>Diagnostic (Explorers) Endodontic Instruments</p>	<p>09</p> 
<p>Page 86-87</p> <p>Excavators</p>	<p>10</p> 
<p>Page 88-89</p> <p>Handles For Mouth Mirrors Mouth Mirrors</p>	<p>11</p> 
<p>Page 90-93</p> <p>Spatulas</p>	<p>12</p> 

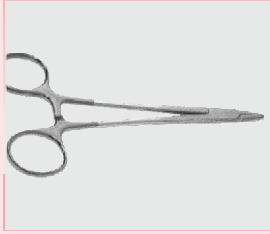

13

Needle Holders &
Saliva Ejectors

Page 94-100

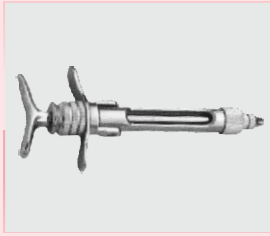

14

Syringes & Scissors

Page 101-109

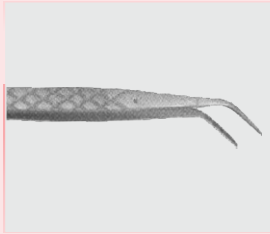

15

Dental Tweezers

Page 110-114

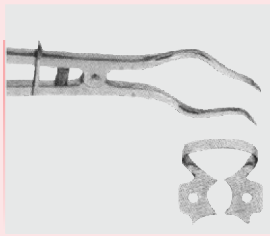

16

Rubber Dam Clamps

Page 115-117

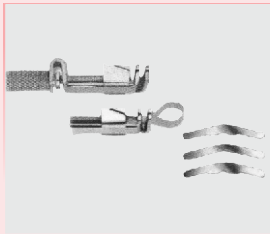

17

Matrix Retainers &
Matrix Bands

Page 118-119

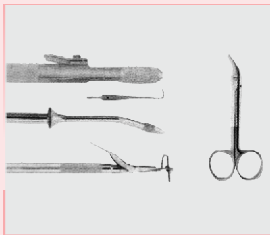



18

Crown Removers, Scissors,
Forceps, Amalgum Guns & Carriers

Page 120-122

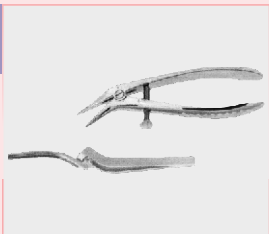
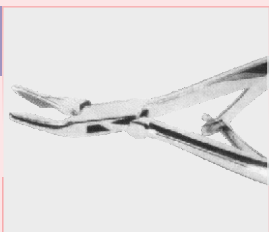
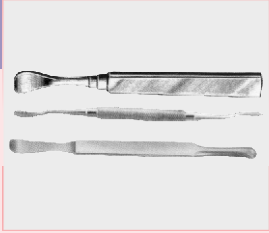
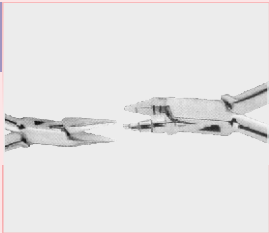
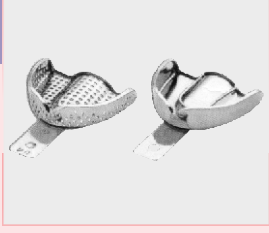
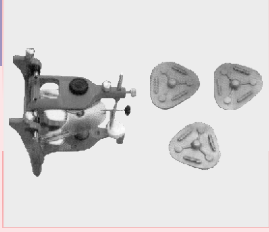
TABLE OF CONTENTS

<p>Page 123</p> <p>Copper Ring Removing Pliers & Paper Articulating Forceps</p>	<p>19</p> 
<p>Page 124-127</p> <p>Rongeurs</p>	<p>20</p> 
<p>Page 128-129</p> <p>Bone Elevators, Files & Chisels</p>	<p>21</p> 
<p>Page 130-151</p> <p>Pliers For Orthodontics, Mouth Gags, Tongue Depressors Lip and Cheek Retractors and Implantology Instrumetns</p>	<p>22</p> 
<p>Page 152-155</p> <p>Impression Trays</p>	<p>23</p> 
<p>Page 156-157</p> <p>Articulators</p>	<p>24</p> 
<p>Page 158-160</p> <p>Hollowares</p>	<p>25</p> 

Page
1-31

- Extracting Forceps - English Pattern

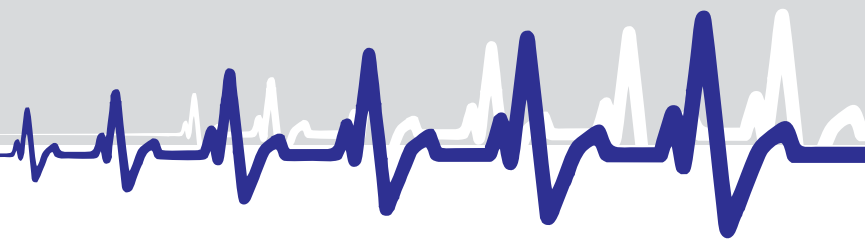



JJ-1-5101
Fig 8
lower premolars



JJ-1-5102
Fig 13
lower premolars

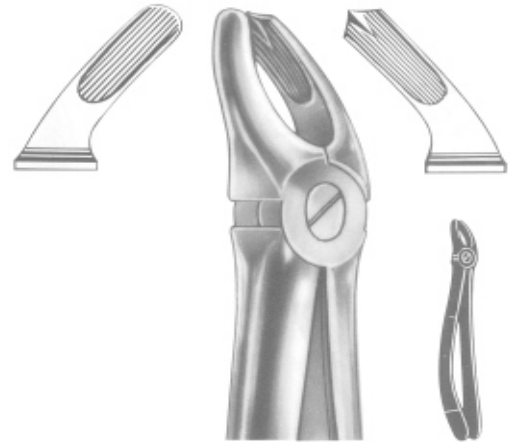

JJ-1-5103
Fig 17
upper molars, right

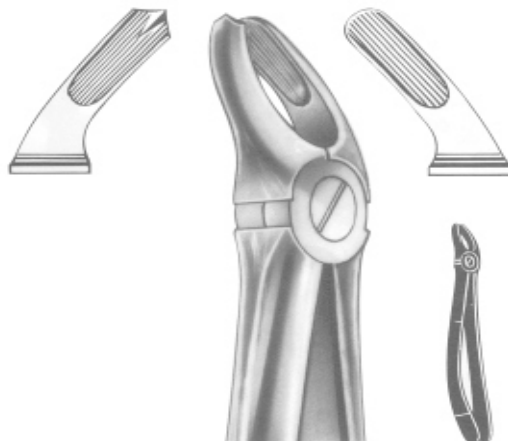

JJ-1-5104
Fig 18
upper molars, left

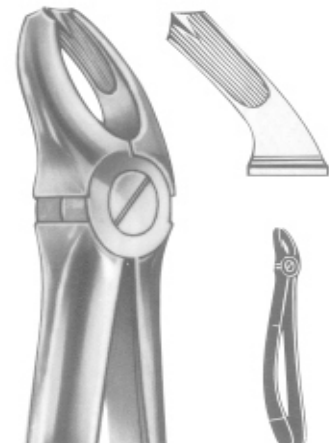

JJ-1-5105
Fig 18 A
upper molars

Extracting Forceps - English Pattern



JJ-1-5106
Fig 19
upper wisdoms

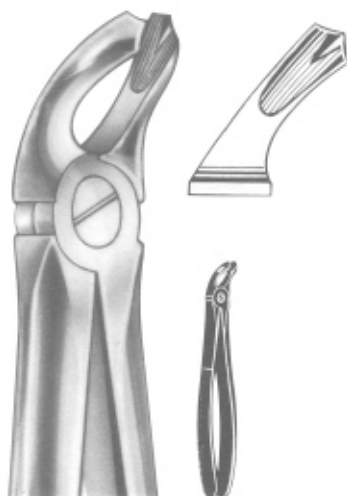

JJ-1-5107
Fig 20
lower wisdoms

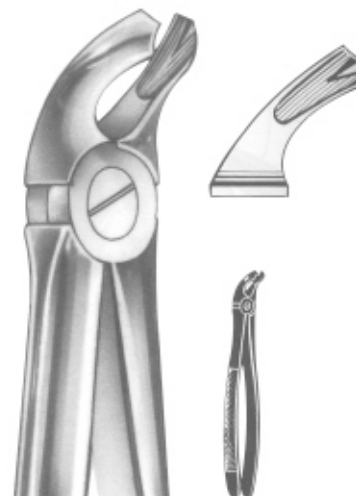

JJ-1-5108
Fig 21
lower molars



JJ-1-5109
Fig 22
lower molars



JJ-1-5110
Fig 22 A
Albrecht
lower molars

Extracting Forceps - English Pattern



JJ-1-5116
Fig 44
upper roots

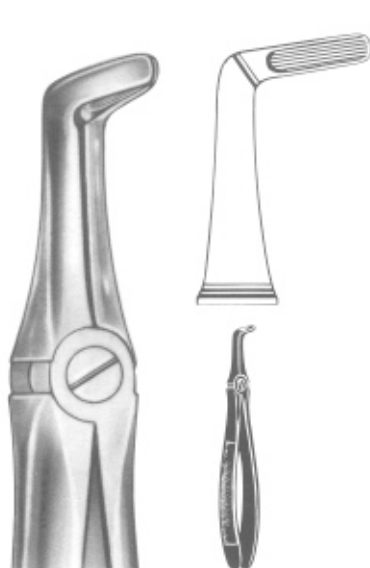

JJ-1-5117
Fig 45
lower roots

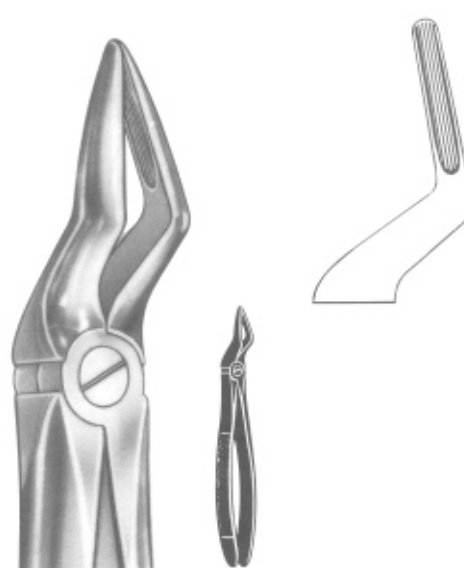

JJ-1-5118
Fig 12
upper roots

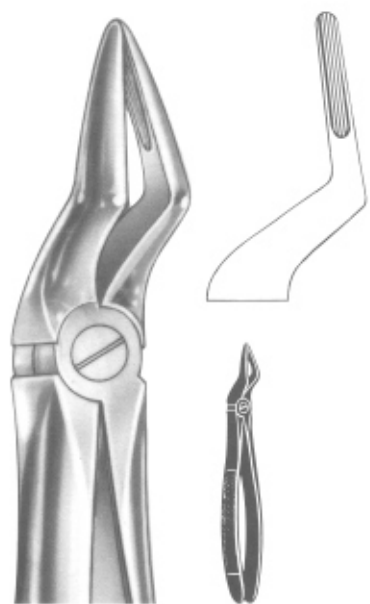

JJ-1-5119
Fig 51 A
upper roots

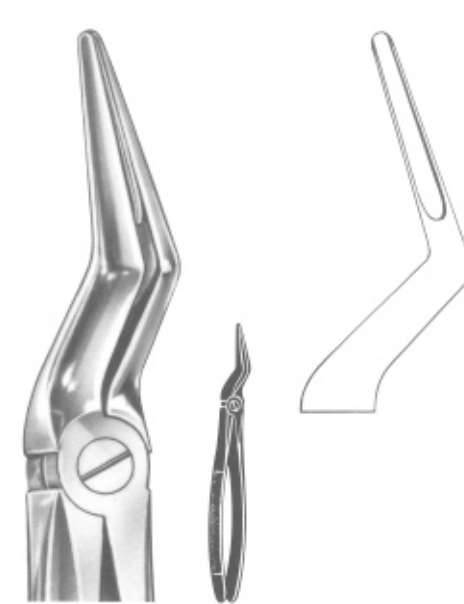

JJ-1-5120
Fig 51 L
upper roots



JJ-1-5111
Fig 33 A
lower roots

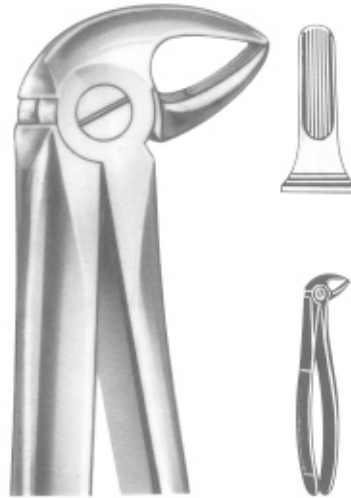

JJ-1-5112
Fig 33 B
lower roots

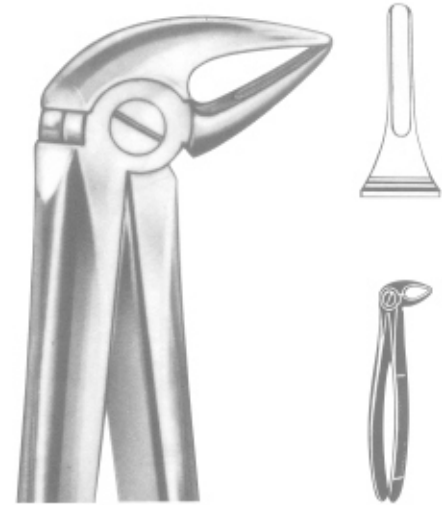

JJ-1-5113
Fig 33 L
lower roots



JJ-1-5114
Fig 33 L
lower roots



JJ-1-5115
Fig 33 S
lower roots, for children



Relax
JJ-1-5121
Fig 51
upper roots



Relax
JJ-1-5122
Fig 51 A
upper roots

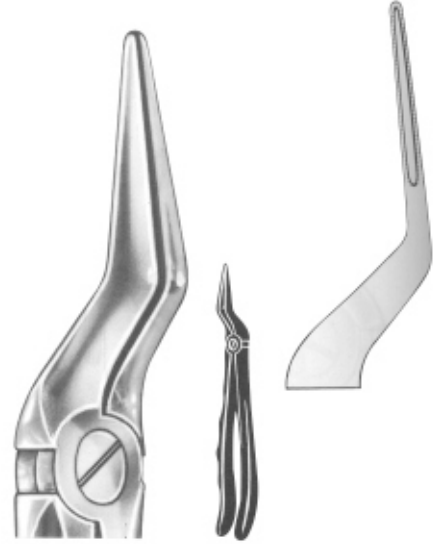

Relax
JJ-1-5123
Fig 51 L
upper roots

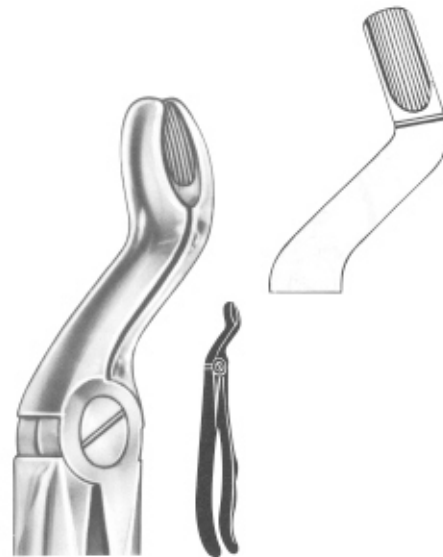

Relax
JJ-1-5124
Fig 67
upper wisdoms

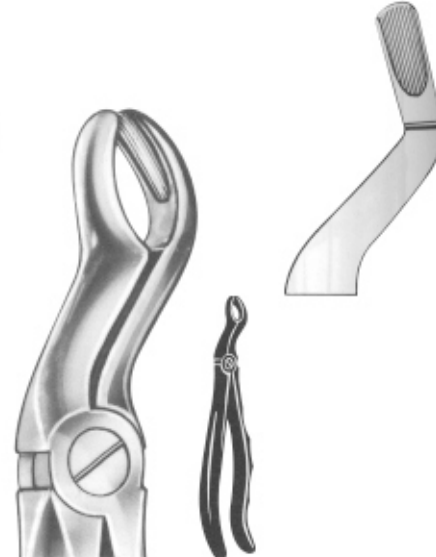

Relax
JJ-1-5125
Fig 67 A
upper wisdoms

Extracting Forceps For Children - English Pattern



JJ-1-5126
Fig 37
Upper incisors



WITH SERRATED
TIPS

JJ-1-5127
Fig 39
Upper molars

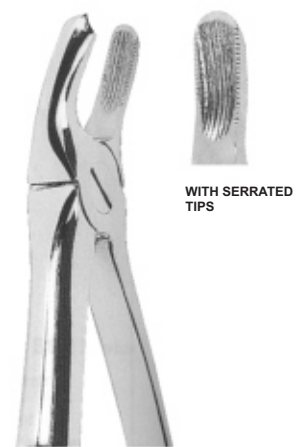

WITH SERRATED
TIPS

JJ-1-5128
Fig 39 R
Upper molars, right

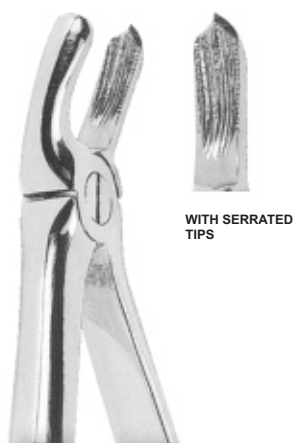

WITH SERRATED
TIPS

JJ-1-5129
Fig 39 L
Upper molars, left



WITH SERRATED
TIPS

JJ-1-5130
Fig 515
Upper roots



Klein
JJ-1-5132
Fig 137
upper incisors



Klein
JJ-1-5131
Fig 6
lower molars



Klein
JJ-1-5133
Fig 5
lower incisors

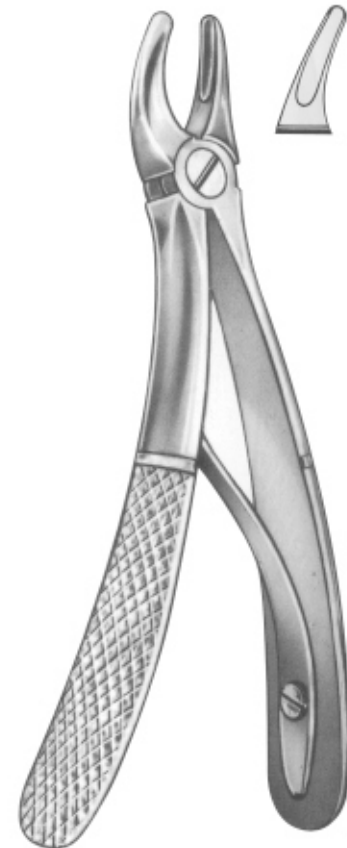

Klein
JJ-1-5134
Fig 139
uper premolars

Extracting Forceps - English Pattern



WITH SERRATED TIPS

JJ-1-5135
Fig 43 A
Fractured or decayed upper teeth

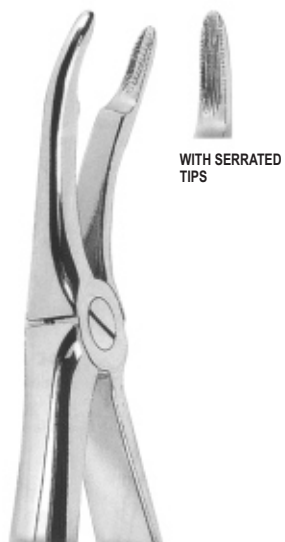

WITH SERRATED TIPS

JJ-1-5136
Fig 44
Upper roots



WITH SERRATED TIPS

JJ-1-5137
Fig 45
Lower roots

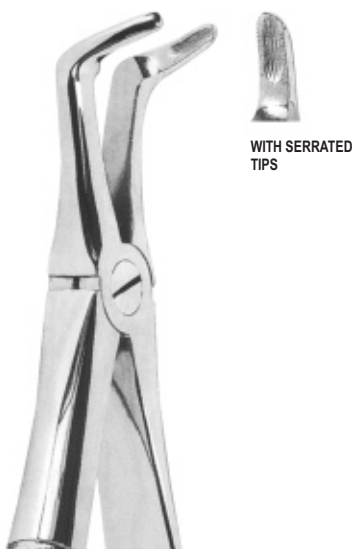

WITH SERRATED TIPS

JJ-1-5138
Fig 46
Lower roots

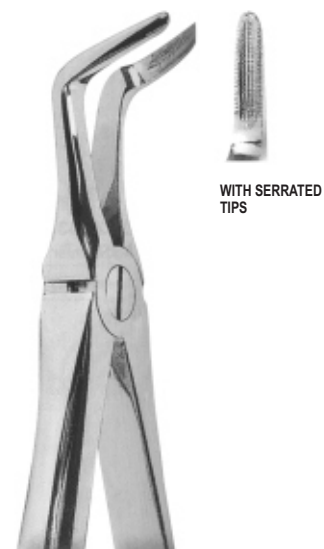

WITH SERRATED TIPS

JJ-1-5139
Fig 46 L
Lower roots



JJ-1-5140
Fig 48
Upper roots



WITH SERRATED
TIPS

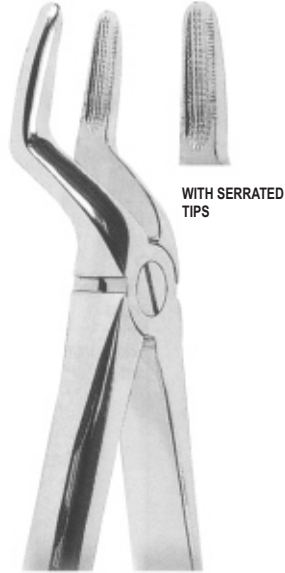

JJ-1-5141
Fig 51
Upper roots

WITH SERRATED
TIPS

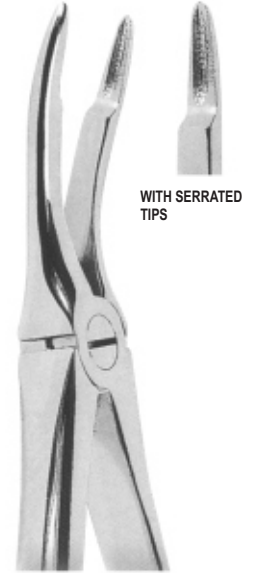

JJ-1-5142
Fig 49
Upper roots

WITH SERRATED
TIPS



JJ-1-5143
Fig 51 L
Upper roots

WITH SERRATED
TIPS



JJ-1-5144
Fig 51 A
Upper roots

WITH SERRATED
TIPS

Extracting Forceps - English Pattern



JJ-1-5145
Fig 51 LX
Upper roots



1046
Fig 52
Upper roots and
canines



JJ-1-5147
Fig 54
For separating
upper molars



JJ-1-5148
Fig 55
For separating
upper molars



JJ-1-5149
Fig 56
For separating
lower molars

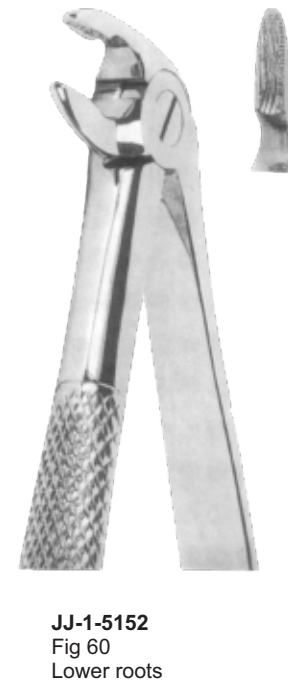
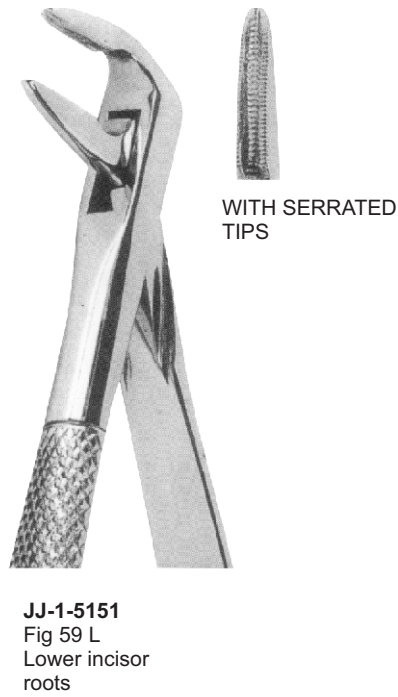

Extracting Forceps - English Pattern



JJ-1-5155
Fig 66 L
Upper molars, left



WITH SERRATED TIPS



JJ-1-5156
Fig 66 R
Upper molars, right



WITH SERRATED TIPS



JJ-1-5157
Fig 67
Upper third molars



WITH SERRATED TIPS



JJ-1-5158
Fig 67 A
Upper third molars



WITH SERRATED TIPS



JJ-1-5159
Fig 68
Lower roots



WITH SERRATED TIPS



JJ-1-5160
Fig 67½ L
Upper third molars, left



WITH SERRATED TIPS



JJ-1-5161
Fig 67½ R
Upper third molars, right



WITH SERRATED TIPS



JJ-1-5162
Fig 73
Lower molars



WITH SERRATED TIPS



JJ-1-5163
Fig 74
Lower roots



WITH SERRATED TIPS



JJ-1-5164
Fig 74 M
Lower roots



WITH SERRATED TIPS

Extracting Forceps - English Pattern



JJ-1-515
Fig 74 N
Lower roots



WITH SERRATED TIPS



JJ-1-5166
Fig 75
Lower canines and premolars



WITH SERRATED TIPS



JJ-1-5167
Fig 79
Lower third molars



WITH SERRATED TIPS



JJ-1-5168
Fig 79 A
Lower third molars



WITH SERRATED TIPS



JJ-1-5169
Fig 79 C
Lower third molars



WITH SERRATED TIPS



JJ-1-5170
Fig 86 W
Lower third molars



JJ-1-5171
Fig 86 1/2 L
Lower third molars, left



JJ-1-5172
Fig 86 1/2 R
Lower third molars, right



JJ-1-5173
Fig 86 C
Lower molars

Extracting Forceps - English Pattern



JJ-1-5174
Fig 87
Lower decayed molars
or broken-down crowns



WITH SERRATED
TIPS

JJ-1-5175
Fig 89
Upper molars, right



WITH SERRATED
TIPS

JJ-1-5176
Fig 90
Upper molars, left

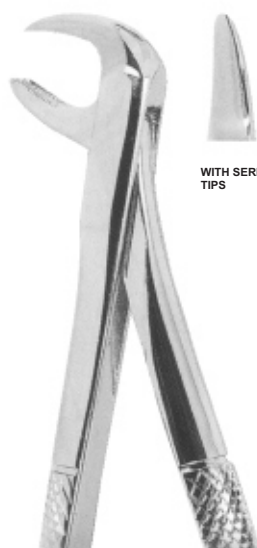

WITH SERRATED
TIPS

JJ-1-5177
Fig 99
Broken-down lower molars

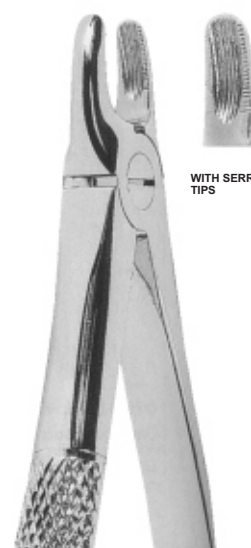

WITH SERRATED
TIPS

JJ-1-5178
Fig 107
Upper canines



JJ-1-5179
Fig 121
Upper third molars

WITH SERRATED TIPS



JJ-1-5180
Fig 145
Lower roots

WITH SERRATED TIPS



JJ-1-5181
Fig 151½
Upper roots

WITH SERRATED TIPS



JJ-1-5182
Fig 166
Universal extracting forceps for upper teeth, in particular molars and premolars

WITH SERRATED TIPS



JJ-1-5183
Fig 167
Universal extracting forceps for lower teeth, in particular molars and premolars

WITH SERRATED TIPS

Extracting Forceps - English Pattern



JJ-1-5184
Fig 168
Upper canines



JJ-1-5185
Fig 169
Lower canines

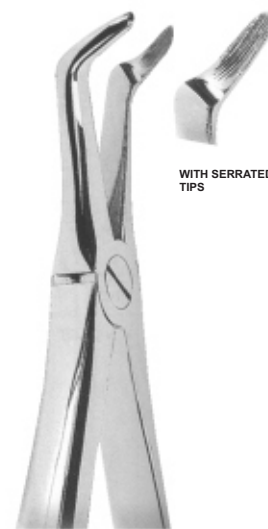

JJ-1-5186
Fig 346
Lower roots

WITH SERRATED TIPS



JJ-1-5187
Fig 349
Upper roots



JJ-1-5188
Fig 359
Lower roots

WITH SERRATED TIPS



WITH SERRATED TIPS

JJ-1-5189
Fig 1
Universal extracting forcep for upper incisors and canines

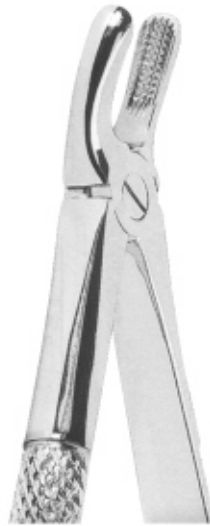

WITH SERRATED TIPS

JJ-1-5190
Fig 2
Upper molars

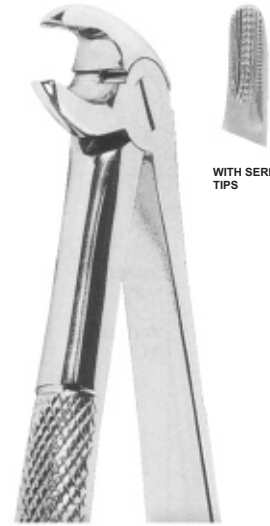

WITH SERRATED TIPS

JJ-1-5191
Fig 3
Lower incisors, premolar and roots



WITH SERRATED TIPS

JJ-1-5192
Fig 4
Lower molars

Extracting Forceps With Anatomically Shaped Handle



JJ-1-5193
Fig 1
Upper incisors
and canines



WITH SERRATED
TIPS

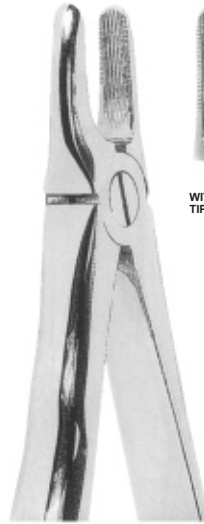

JJ-1-5194
Fig 2
Upper incisors
and canines

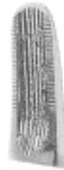

WITH SERRATED
TIPS



JJ-1-5195
Fig 4
Lower incisors
and canines



WITH SERRATED
TIPS



JJ-1-5196
Fig 7
Upper premolars



WITH SERRATED
TIPS



JJ-1-5197
Fig 13
Lower premolars



WITH SERRATED
TIPS



JJ-1-5198
Fig 17
Upper molars, right



WITH SERRATED TIPS

JJ-1-5199
Fig 18
Upper molars, left

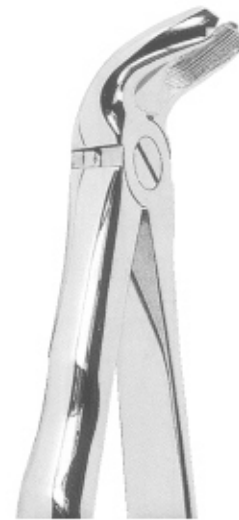

WITH SERRATED TIPS

JJ-1-5200
Fig 21
Lower molars



WITH SERRATED TIPS

JJ-1-5201
Fig 22
Lower molars



WITH SERRATED TIPS

JJ-1-5202
Fig 33
Lower roots

Extracting Forceps With Anatomically Shaped Handle



JJ-1-5203
Fig 45
Lower roots



WITH SERRATED TIPS



JJ-1-5204
Fig 51 A
Upper roots

WITH SERRATED TIPS



JJ-1-5205
Fig 67 A
Upper third molars

WITH SERRATED TIPS



JJ-1-5206
Fig 74
Lower roots

WITH SERRATED TIPS

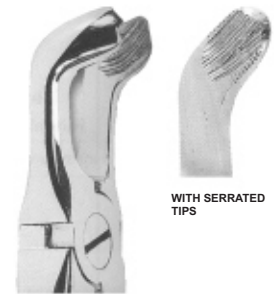

JJ-1-5207
Fig 79
Lower third molars

WITH SERRATED TIPS



JJ-1-5208
Fig 86 C
Lower molars

WITH SERRATED TIPS



JJ-1-5209
Fig 359
Lower roots

WITH SERRATED TIPS



JJ-1-5210
Fig 89
Upper molars, right



JJ-1-5211
Fig 90
Upper molars, left

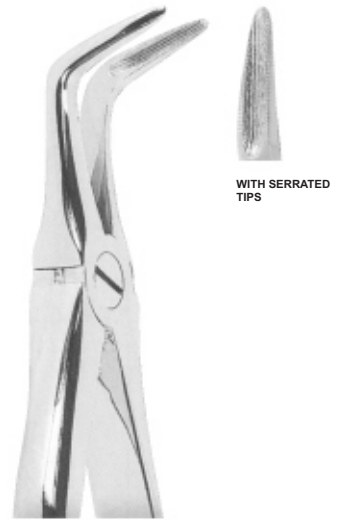

JJ-1-5212
Fig 145
Lower roots



JJ-1-5213
Fig 151 1/2
Upper roots

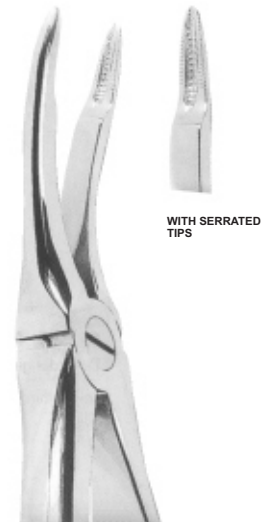

JJ-1-5214
Fig 349
Upper roots

Extracting Forceps - American Pattern



JJ-1-5215
Fig 5
Lower third molars



JJ-1-5216
Fig 6
Separating forcep



JJ-1-5217
Fig 105
Upper molars



JJ-1-5218
Fig 16
Lower molars



JJ-1-5219
Fig 17
Lower molars



JJ-1-5220
Fig 18 L
Upper molars, left



JJ-1-5221
Fig 18 R
Upper molars, right



JJ-1-5222
Fig 23
Lower molars



JJ-1-5223
Fig 53 R
Upper molars, right



JJ-1-5224
Fig 53 L
Upper molars, left

Extracting Forceps - American Pattern



JJ-1-5225
Fig 65
Upper incisors and roots



JJ-1-5226
Fig 69
Upper and lower roots



JJ-1-5227
Fig 88 R
Upper molars, right



JJ-1-5228
Fig 88 L
Upper molars, left



JJ-1-5229
Fig 101
Deciduous teeth



JJ-1-5230
Fig 150
Upper incisors, premolars, roots

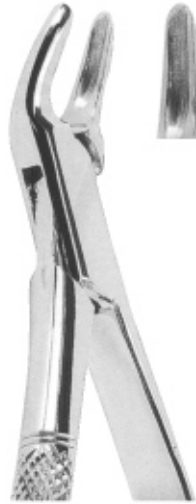

JJ-1-5231
Fig 150 S
Upper teeth (for children)



JJ-1-5232
Fig 151
Upper incisors, premolars, roots



JJ-1-5233
Fig 151S
Lower teeth (for children)



JJ-1-5234
Fig 222
Lower third molars

Extracting Forceps - American Pattern



JJ-1-5235
Fig 1
upper incisors and bicuspid

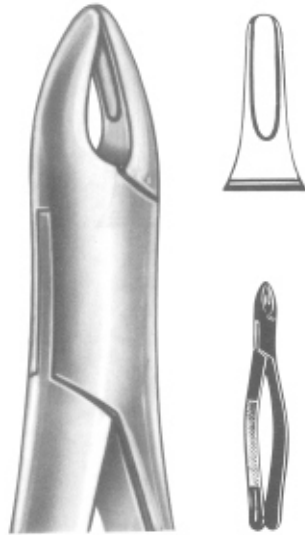

JJ-1-5236
Fig 1 B
upper roots, anterior

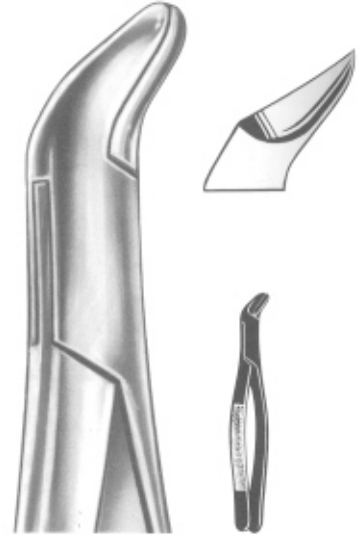

Physick
JJ-1-5237
Fig 5
lower wisdoms

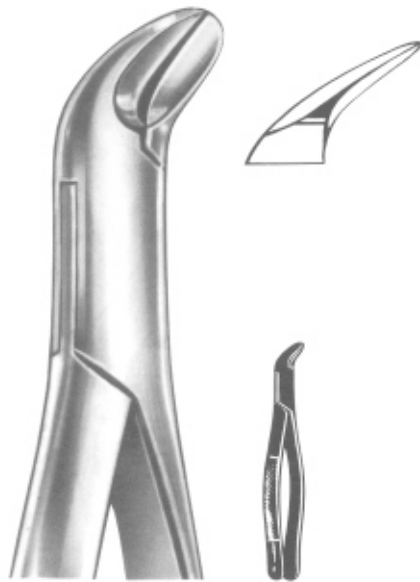

JJ-1-5238
Fig 6
lower molars, splitting forceps

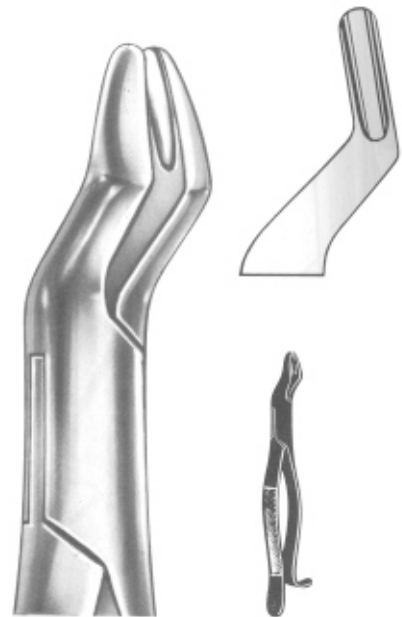

JJ-1-5239
Fig 10 H
upper molars



WITH SERRATED
TIPS

JJ-1-5240
Fig 135
Lower premolars



JJ-1-5241
Fig 225
Lower molars



JJ-1-5242
Fig 305
Upper incisors
and roots



WITH SERRATED
TIPS

JJ-1-5243
Fig 33 S
Lower roots



WITH SERRATED
TIPS

JJ-1-5244
Fig 38
Lower incisors
and canines

Extracting Forceps For Children - Klein Pattern



JJ-1-5245
Fig 1
Upper incisors



WITH SERRATED
TIPS



JJ-1-5246
Fig 2
Upper permolars



WITH SERRATED
TIPS



JJ-1-5247
Fig 3
Upper molars



WITH SERRATED
TIPS



JJ-1-5248
Fig 4
Upper roots



WITH SERRATED
TIPS



JJ-1-5249
Fig 5
Lower incisors



WITH SERRATED
TIPS



JJ-1-5250
Fig 6
Lower molars



WITH SERRATED
TIPS



JJ-1-5251
Fig 7
Lower roots



WITH SERRATED
TIPS



JJ-1-5252
Fig 1
Lower roots



JJ-1-5253
Fig 2
Upper roots



JJ-1-5255
Fig 2
Roots fragments



JJ-1-5254
Fig 1
Roots fragments

Page 32–50

- Root Elevators

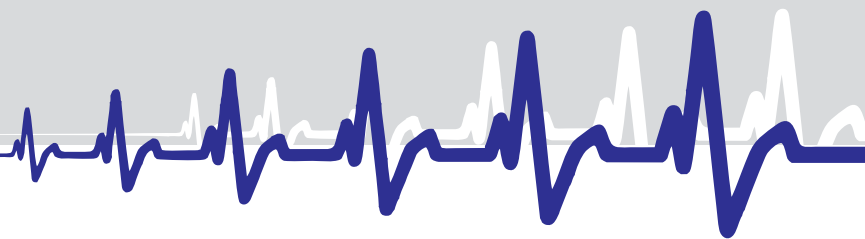

lower jaw, left side

lower jaw, right side

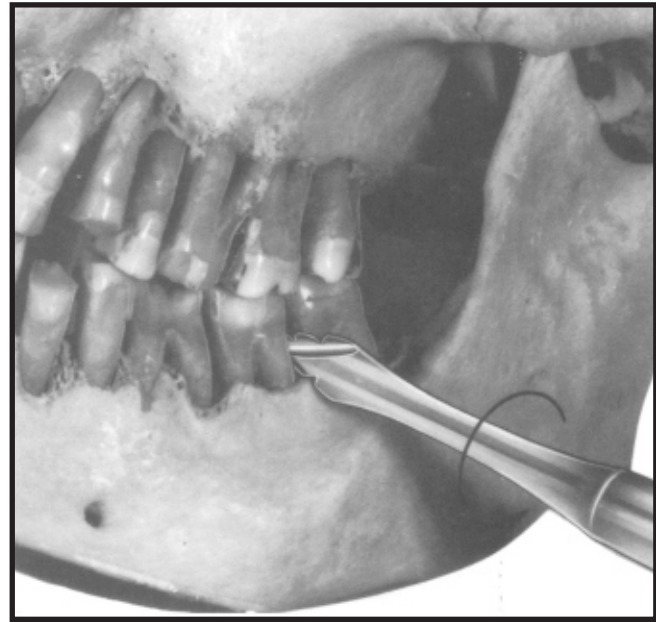

Root elevator, spiral-shaped, for extremely facilitated extraction of the molars in the lower jaw. The slender, conical points allow deep penetration between tooth and gum. Owing to the hook-shaped working parts, slipping of the elevator is avoided.



JJ-2-5101



JJ-2-5102

Root Elevators



Bein

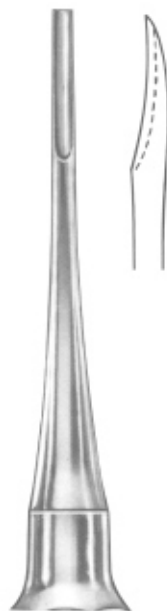

**Bein
JJ-2-5103
Fig 1**



**Bein
JJ-2-5104
Fig 2**

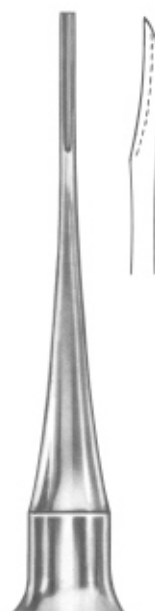

**Bein
JJ-2-5105
Fig 0**



**Bein
JJ-2-5106
Fig 3**

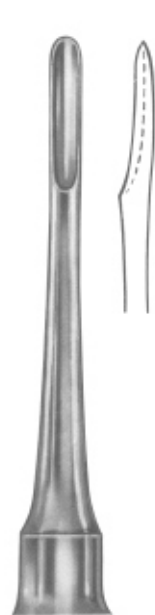

**Bein
JJ-2-5107
Fig 4**



**Bein
JJ-2-5108
Fig 5**



**Bein
JJ-2-5109
Fig 6**



Seldin



Seldin
JJ-2-5110
Fig 1L



Seldin
JJ-2-5111
Fig 1R



Seldin
JJ-2-5112
Fig 2



Seldin
JJ-2-5113
Fig 3



Seldin
JJ-2-5114
Fig 4L



Seldin
JJ-2-5115
Fig 4R

Root Elevators



**Cryer
JJ-2-5116
Fig 3**



**Cryer
JJ-2-5117
Fig 4**



**Cryer
JJ-2-5118
Fig 12**



**Cryer
JJ-2-5119
Fig 27**



**Cryer
JJ-2-5120
Fig 28**



**Cryer
JJ-2-5121
Fig 27 S**



**Cryer
JJ-2-5122
Fig 28 S**



Apical



Apical
JJ-2-5123
Fig 1



Apical
JJ-2-5124
Fig 2



Apical
JJ-2-5125
Fig 3



Apical
JJ-2-5126
Fig 4

Root Elevators



Cryer



**Cryer
JJ-2-5127
Fig 1**

**Cryer
JJ-2-5128
Fig 2**



Coupland

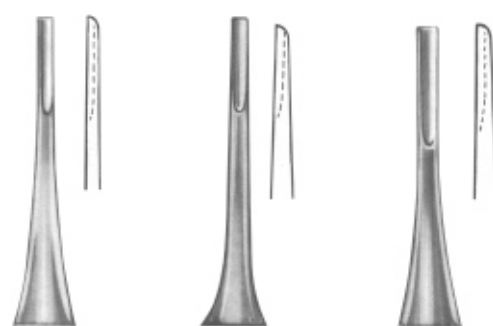

**Coupland
JJ-2-5129
Fig 1**

**Coupland
JJ-2-5130
Fig 2**

**Coupland
JJ-2-5131
Fig 3**



JJ-2-5132
Fig 1

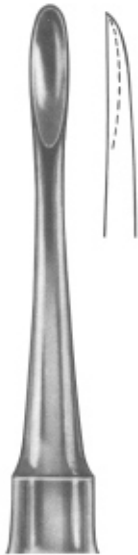

JJ-2-5133
Fig 2



JJ-2-5134
Fig 3



Flohr
JJ-2-5135
Fig 1



Flohr
JJ-2-5136
Fig 2



Flohr
JJ-2-5137
Fig 3

Root Elevators



Kopp
JJ-2-5138
Fig 1



Kopp
JJ-2-5139
Fig 2



Kopp
JJ-2-5144
Fig 1



Kopp
JJ-2-5145
Fig 2



Kopp



Kopp
JJ-2-5140
Fig 3



Kopp
JJ-2-5141
Fig 4



Kopp



Kopp
JJ-2-5146
Fig 3



Kopp
JJ-2-5147
Fig 4



Kopp
JJ-2-5142
Fig 5



Kopp
JJ-2-5143
Fig 6



Hylin
JJ-2-5148
Fig 1

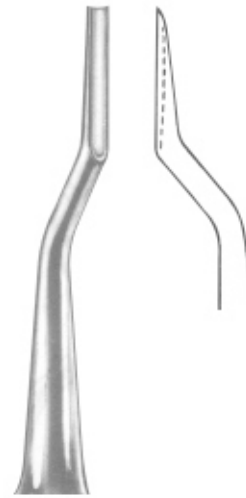

Bein
JJ-2-5150
Fig 1

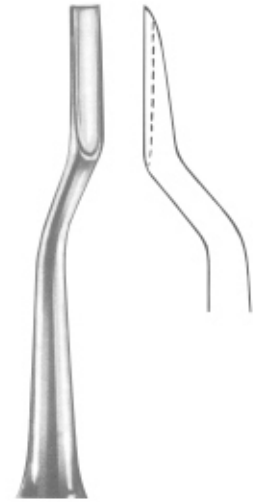

Bein
JJ-2-5151
Fig 2



Hylin



Hylin
JJ-2-5149
Fig 2



Bein



Bein
JJ-2-5152
Fig 3

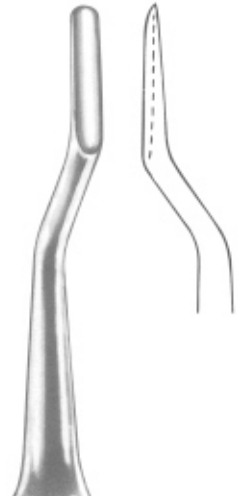

Bein
JJ-2-5153
Fig 4

Root Elevators



**Warwick-James
JJ-2-5154
Fig 1**



**Warwick-James
JJ-2-5155
Fig 2**



**Warwick-James
JJ-2-5156
Fig 3**

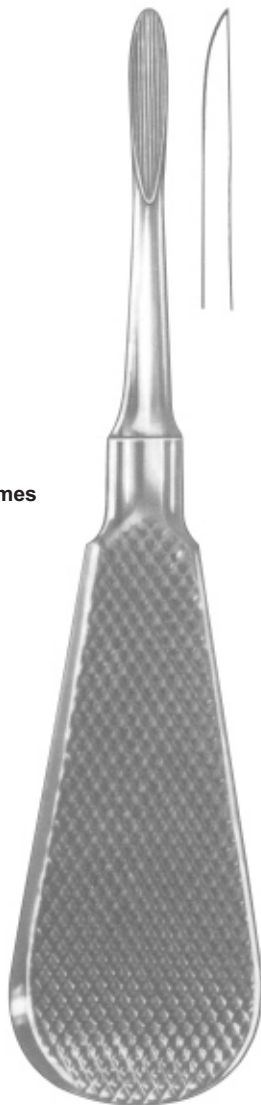

**London Hospital
JJ-2-5157
Fig 1**



**London Hospital
JJ-2-5158
Fig 2**



**London Hospital
JJ-2-5159
Fig 3**

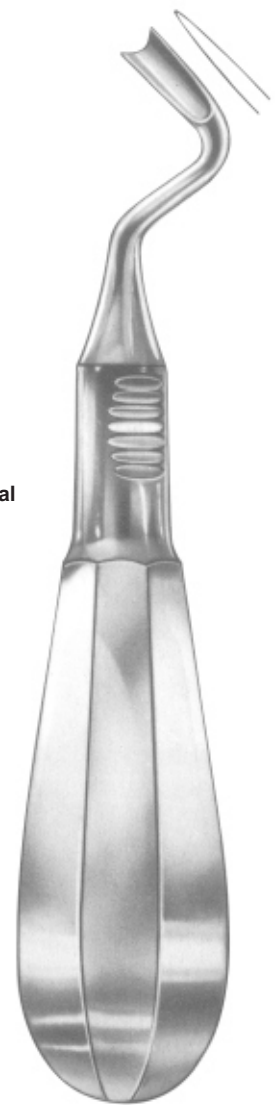

**Ott
JJ-2-5160**

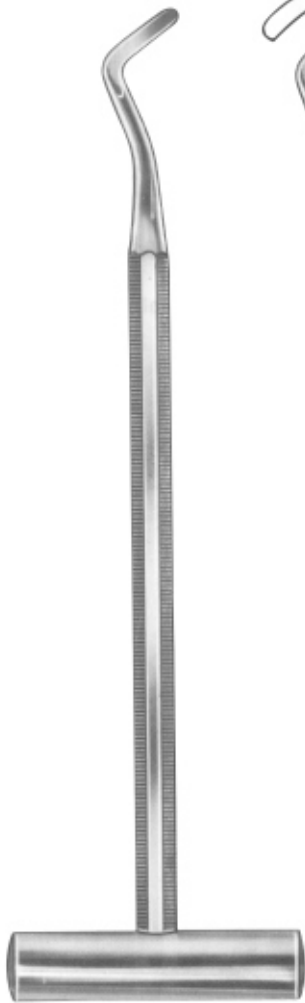

Pott



Pott
JJ-2-5162
Fig 1

Pott
JJ-2-5163
Fig 2

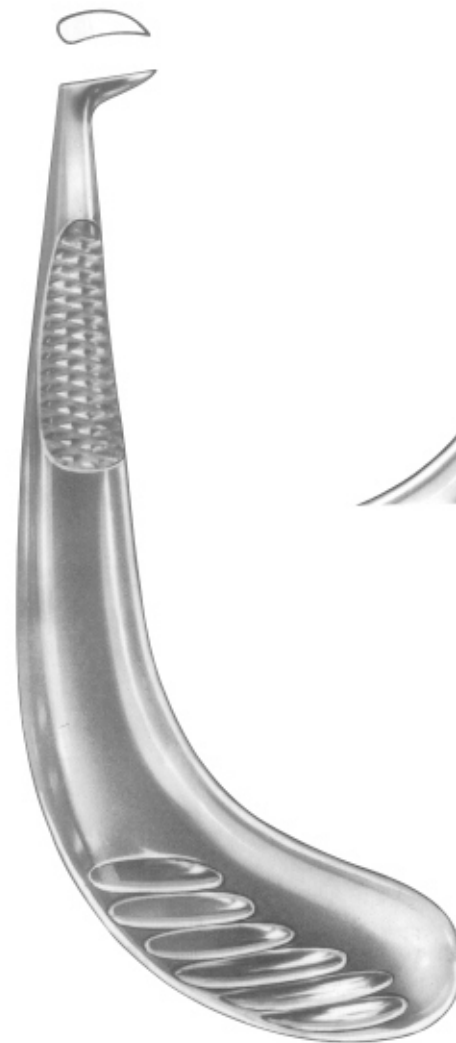

JJ-2-5164
Fig 1

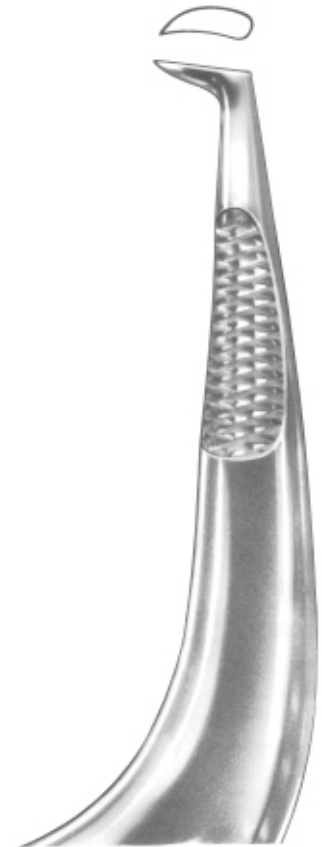

JJ-2-5165
Fig 2

Root Elevators



**Mead
JJ-2-5166
MD 1**



**Mead
JJ-2-5167
MD-5 A**



**Mead
JJ-2-5168
MD-6 A**



**Mead
JJ-2-5169
MD-7 A**



**Mead
JJ-2-5170
MD-8**

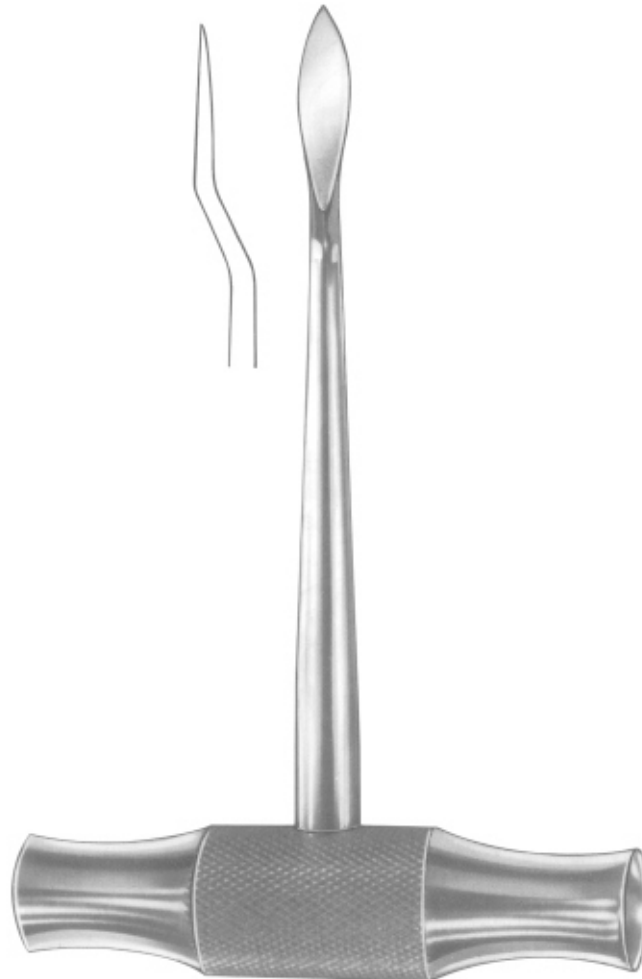

**Lecluse
JJ-2-5171**



Chompret
JJ-2-5172
Fig 1



Chompret
JJ-2-5173
Fig 2



Chompret
JJ-2-5174
Fig 3



Chompret
JJ-2-5175
Fig 4



Apical
JJ-2-5176

Root Elevators Root Tip Elevators



JJ-2-5177
Fig 1



JJ-2-5178
Fig 2



JJ-2-5179
Fig 3



Heidbrink
JJ-2-5180
Fig 1



Heidbrink
JJ-2-5181
Fig 2



Heidbrink
JJ-2-5182
Fig 3



Winter
JJ-2-5183
Fig 1L



Winter
JJ-2-5184
Fig 1R



Winter
JJ-2-5185
Fig 2L



Winter
JJ-2-5186
Fig 2R



Winter



Winter
JJ-2-5187
Fig 11 L



Winter
JJ-2-5188
Fig 11 R



Winter
JJ-2-5189
Fig 12 L



Winter
JJ-2-5190
Fig 12 R



Winter
JJ-2-5191
Fig 14 L



Winter
JJ-2-5192
Fig 14 R

Root Elevators



**Barry
JJ-2-5193
Fig 1**



**Barry
JJ-2-5194
Fig 2**



**Barry
JJ-2-5195
Fig 3**



**Barry
JJ-2-5196
Fig 4**



Barry



**Barry
JJ-2-5197
Fig 11**



**Barry
JJ-2-5198
Fig 12**



**Barry
JJ-2-5199
Fig 17**



**Barry
JJ-2-5200
Fig 18**



Cryer
JJ-2-5201
Fig 26



Seldin
JJ-2-5202
Fig 27



Cryer
JJ-2-5203
Fig 28



Cryer
JJ-2-5204
Fig 29



Heidbrink
JJ-2-5205
Fig 22



Heidbrink
JJ-2-5206
Fig 23



JJ-2-5207

Root Elevators



Kopp
JJ-2-5208
Fig 31



Kopp
JJ-2-5209
Fig 32



Kopp
JJ-2-5210
Fig 33



Kopp
JJ-2-5211
Fig 34



Kopp
JJ-2-5212
Fig 35



Kopp
JJ-2-5213
Fig 44



JJ-2-5214



Heidbrink
JJ-2-5215
Fig 10



Winter
JJ-2-5216
Fig 11



Winter
JJ-2-5217
Fig 12



Barry
JJ-2-5218
Fig 17



Barry
JJ-2-5219
Fig 18



JJ-2-5220
Fig 20



JJ-2-5221

Root Elevators

Root Elevators according to Dr. Sader,
with interchangeable working tips



JJ-2-5222



JJ-2-5223



JJ-2-5224

Page 51–55

- Filling Instruments

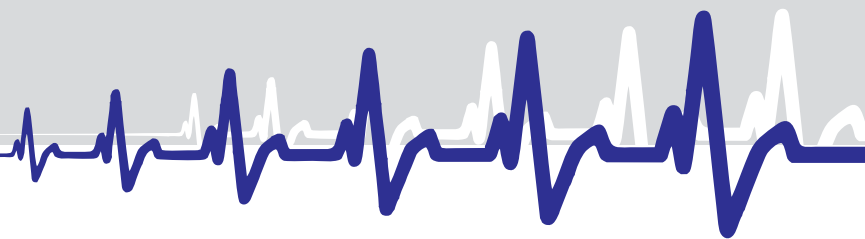



JJ-2-5225
Williams

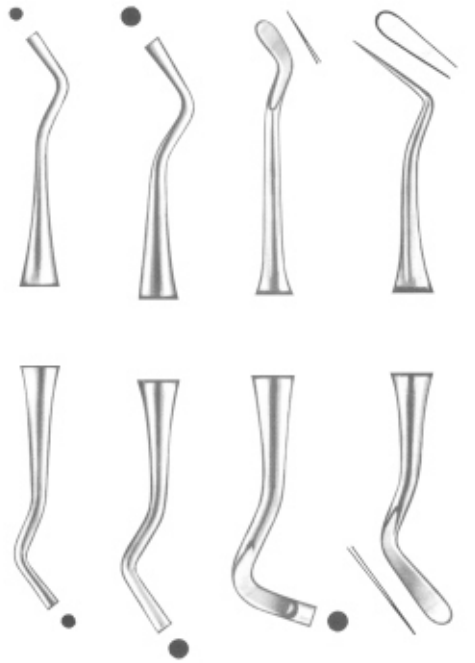

JJ-2-5226 Williams
JJ-2-5227 Williams
JJ-2-5228 Williams
JJ-2-5229 Williams

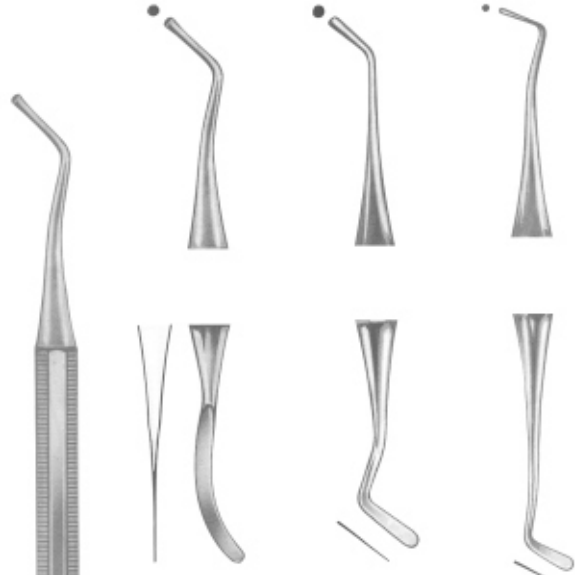

JJ-2-5234 White
JJ-2-5235 White
JJ-2-5236 White

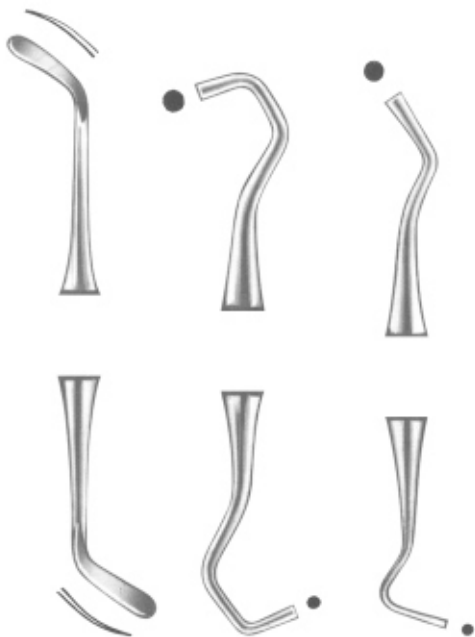

JJ-2-5230 Williams
JJ-2-5231 Williams
JJ-2-5232 Williams

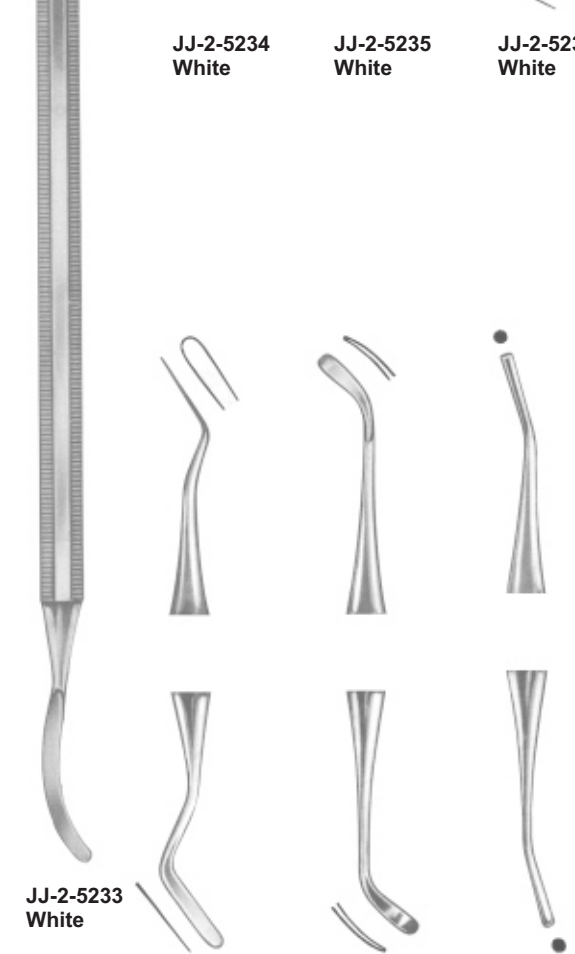

JJ-2-5233 White
JJ-2-5237 White
JJ-2-5238 White
JJ-2-5239 White

Filling Instruments

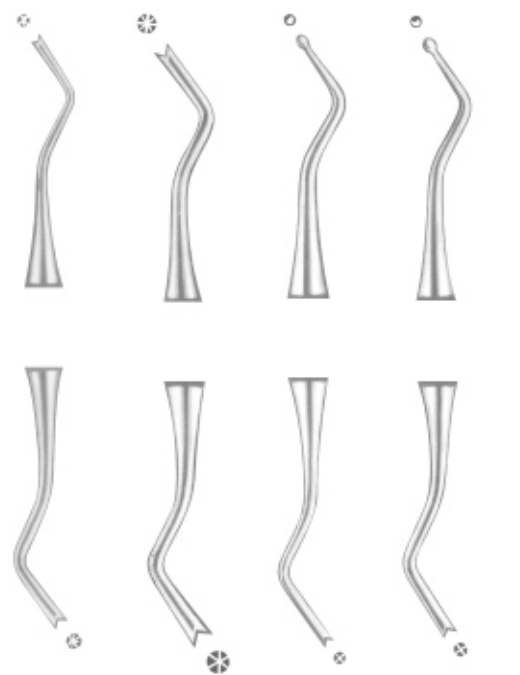
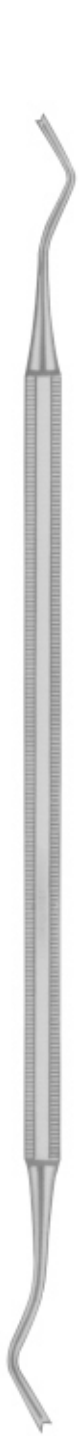

JJ-2-5241 JJ-2-5242 JJ-2-5243 JJ-2-5244

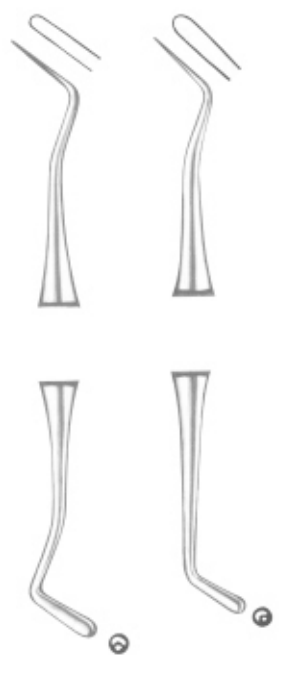

JJ-2-5250 Ash JJ-2-5251 Ash

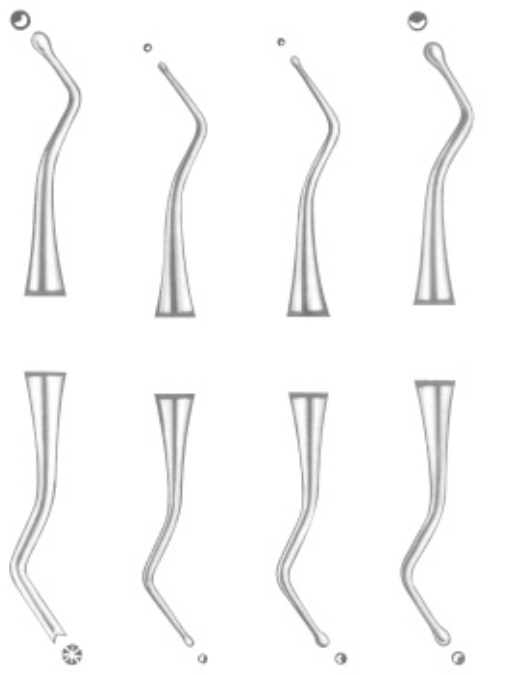

JJ-2-5245 JJ-2-5246 JJ-2-5247 JJ-2-5248

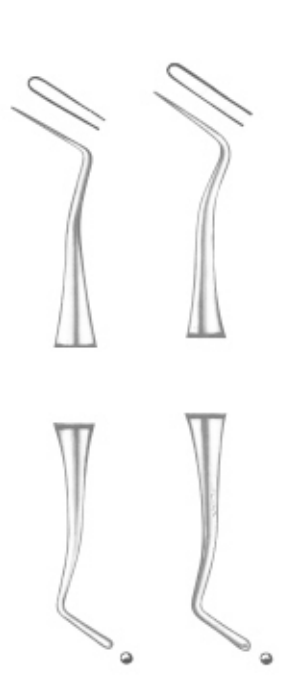

JJ-2-5252 Ash JJ-2-5253 Ash

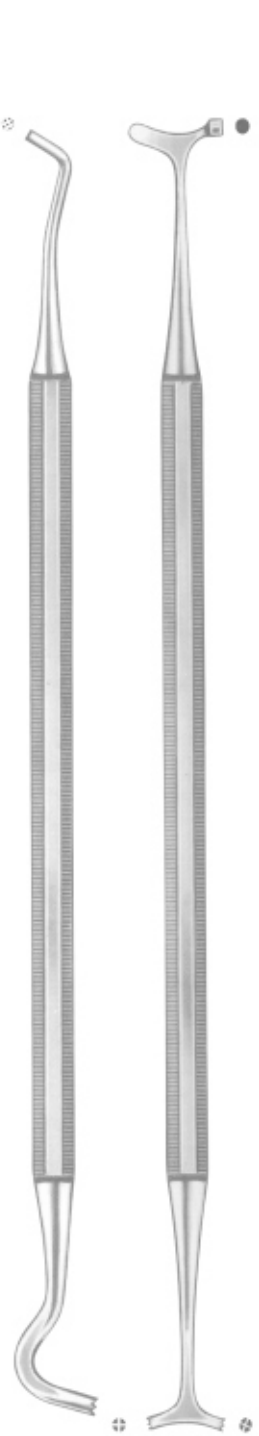

JJ-2-5254 Elliott JJ-2-5255 Bennett

JJ-2-5240

JJ-2-5249 Ash

JJ-2-5254 Elliott

JJ-2-5255 Bennett

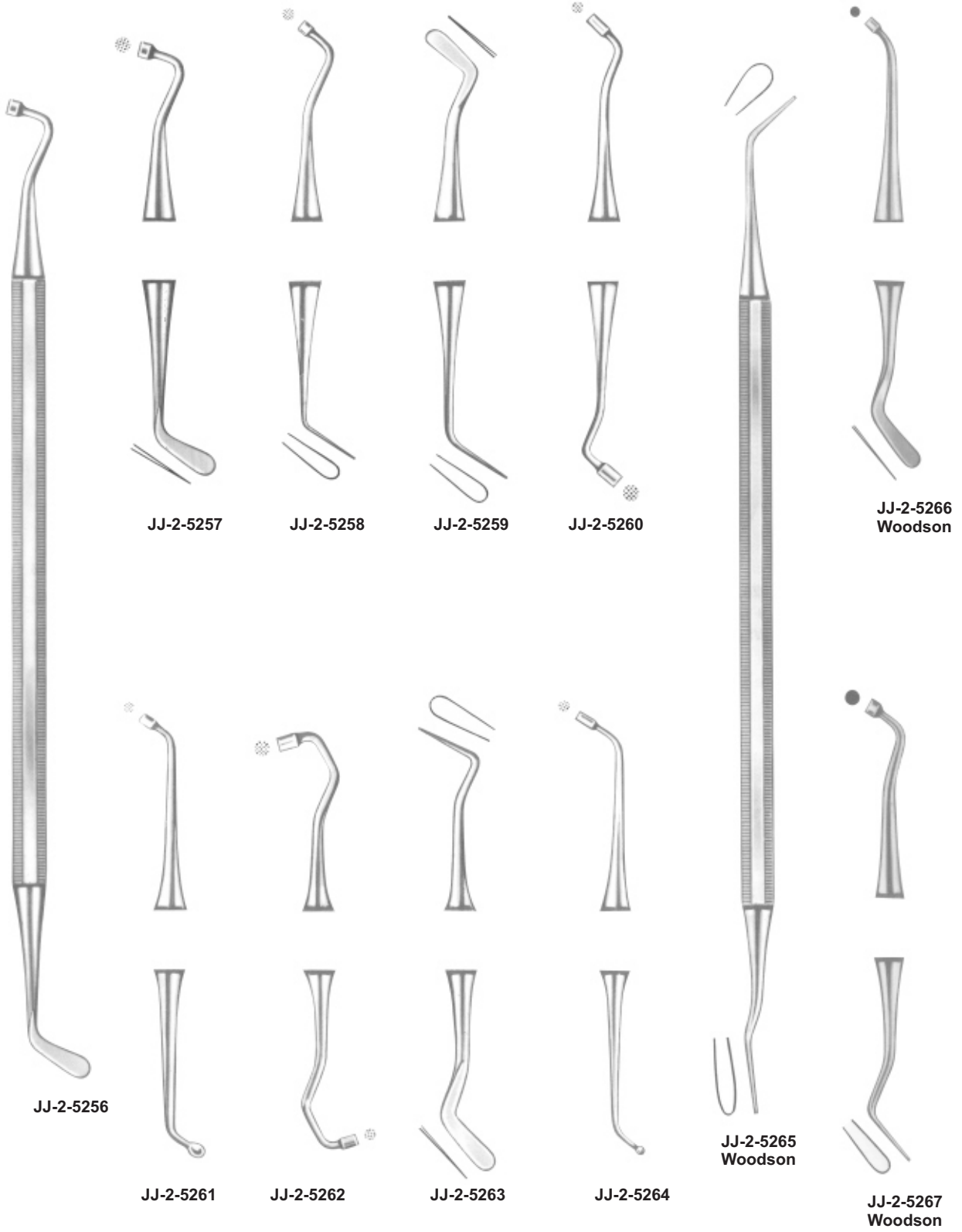

Filling Instruments

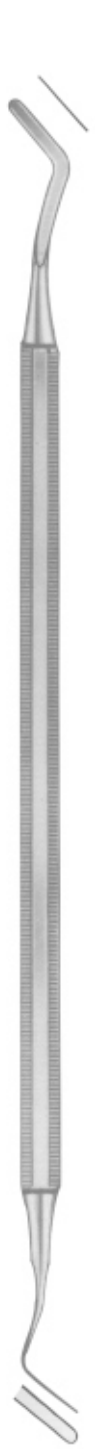

JJ-2-5268
Heidemann
Fig 1



JJ-2-5269
Heidemann
Fig 2



JJ-2-5270
Heidemann
Fig 3

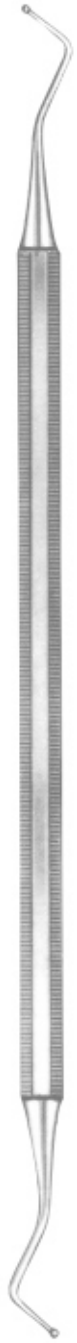

JJ-2-5271



JJ-2-5272
Fig 146



JJ-2-5274
Fig 148



JJ-2-5273
Fig 147



JJ-2-5275
Fig 149

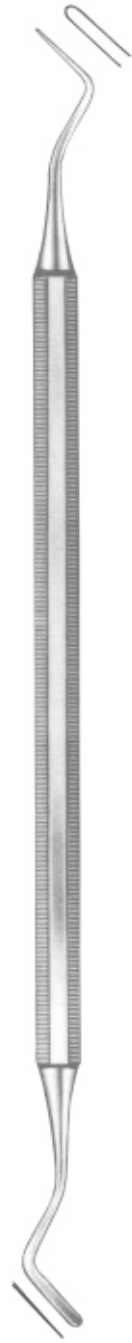

JJ-2-5276
Fig 158

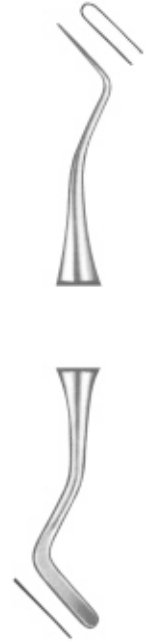

JJ-2-5277
Fig 159

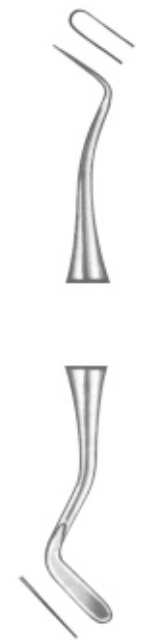

JJ-2-5278
Woodson
Fig 160



JJ-2-5279
Gracey



JJ-2-5280
Gracey
Fig 1



JJ-2-5281
Gracey
Fig 2



JJ-2-5282
Gracey
Fig 3



JJ-2-5283
Gracey
Fig 4



JJ-2-5284
Gracey
Fig 5

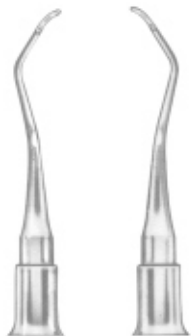

JJ-2-5285
Gracey
Fig 6

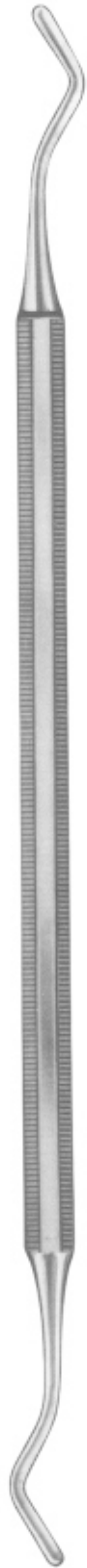

JJ-2-5286



JJ-2-5287
Fig 18



JJ-2-5288
Fig 19



JJ-2-5289
Fig 20



JJ-2-5290
Fig 22



JJ-2-5291
Fig 23



JJ-2-5292
Fig 25



JJ-2-5293
Fig 26



JJ-2-5294
Fig 27



Page 56–59

- Dental Probes

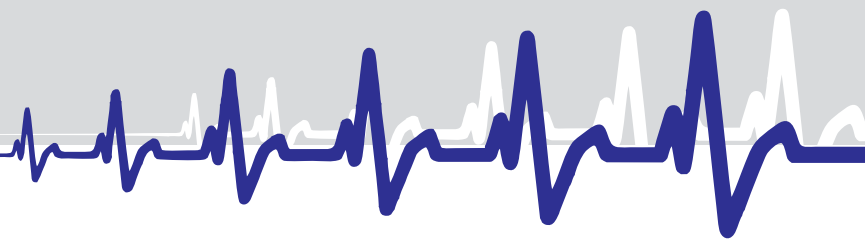

Dental Probes

With Point Set In



JJ-2-5295



JJ-2-5296



JJ-2-5297



JJ-2-5298



JJ-2-5299



JJ-2-5300



JJ-2-5301



JJ-2-5302



JJ-2-5303



JJ-2-5304



JJ-2-5305



JJ-2-5306



JJ-2-5307
Woodson

Polishing Instruments

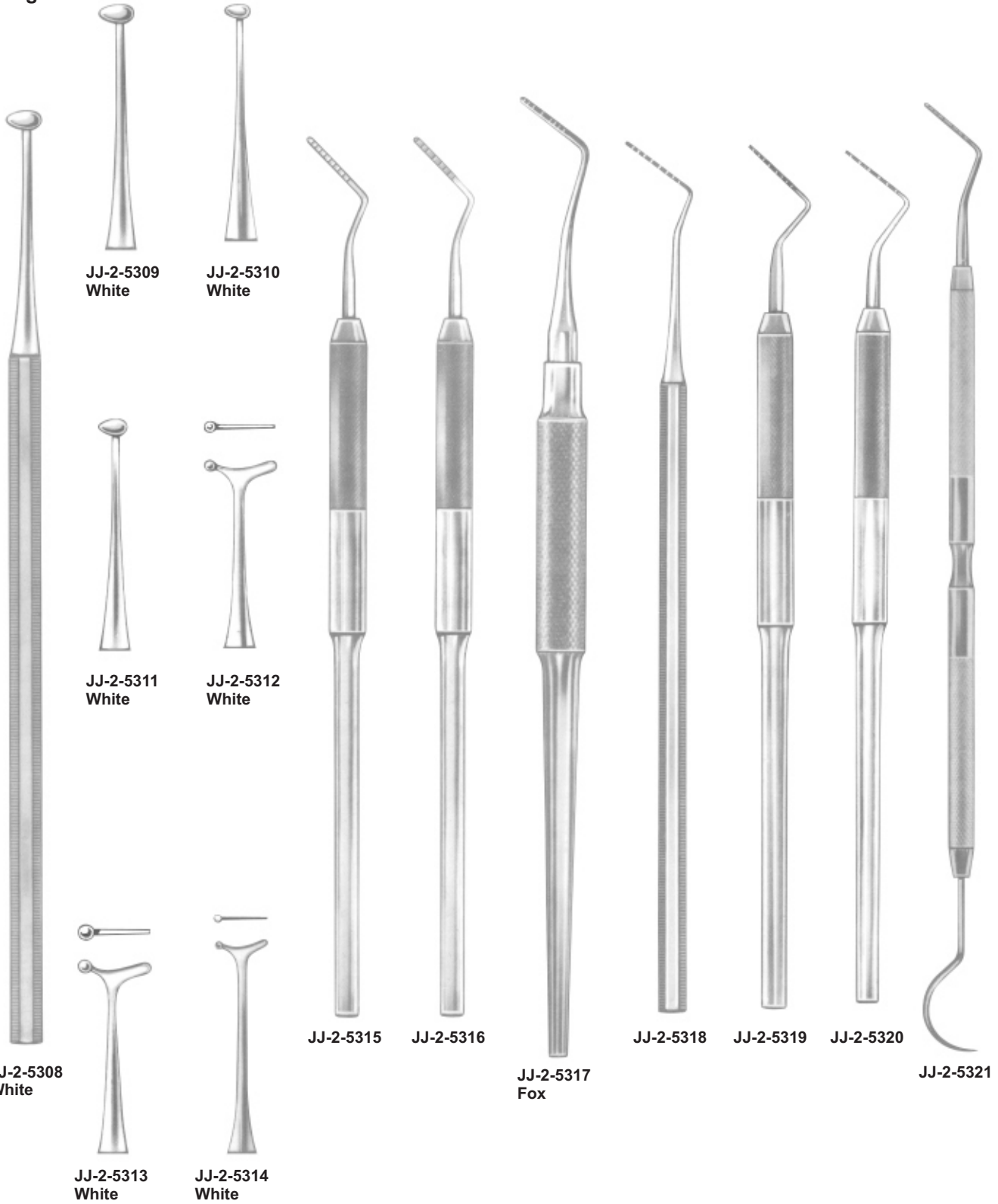

JJ-2-5309
White

JJ-2-5310
White

JJ-2-5311
White

JJ-2-5312
White

JJ-2-5308
White

JJ-2-5313
White

JJ-2-5314
White

JJ-2-5315

JJ-2-5316

JJ-2-5317
Fox

JJ-2-5318

JJ-2-5319

JJ-2-5320

JJ-2-5321

Periodontal Pocket Probes

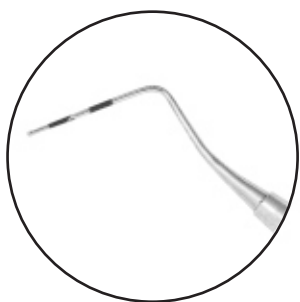

- New marking process.
- Laser system marking.
- No more paint peeling off.
- Permanent marking.
- Antiglare, low depth marking.
- Maximum tip resistance against breaking.



JJ-2-5322
Fig CP-C



JJ-2-5323
Fig CP-11



JJ-2-5324
Fig CP-12



JJ-2-5325
Fig CP-12S
O.M.S



JJ-2-5326
Williams



JJ-2-5327
Merrit A



JJ-2-5328
Merrit B



JJ-2-5329
Goldman
Fox



JJ-2-5330
University of
Michigan



JJ-2-5331
26 G

Page 60–67

- Periodontia Instruments, Mallets

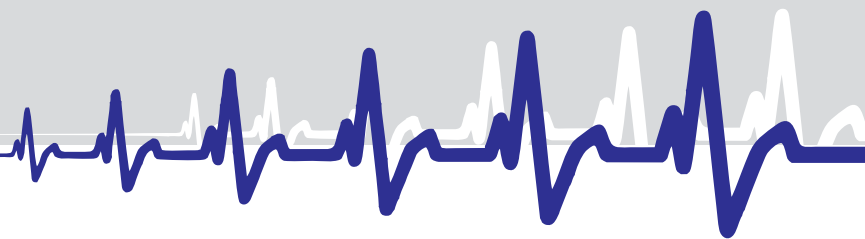

Files

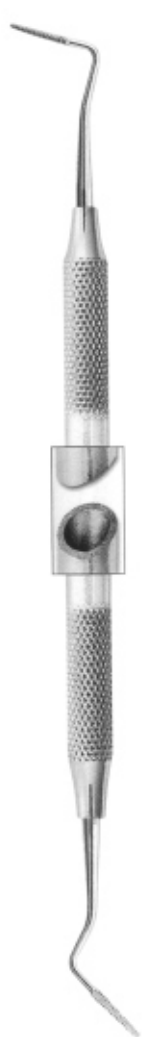

JJ-3-5108
Sugarman
Fig. 1S/2S



JJ-3-5109
Sugarman
Fig. 3S/4S



JJ-3-5110
Schluger
Fig. 9/10



JJ-3-5111
Buck
Fig. 11/12



Chisels



JJ-3-5112
Ochsenbein
Fig. 3



JJ-3-5113
Ochsenbein
Fig. 4



JJ-3-5114
Rhodes
Back - Action
Fig. 36/37

Files

Chisels



JJ-3-5101
Sugarman
Fig. 1S/2S



JJ-3-5102
Sugarman
Fig. 3S/4S



JJ-3-5103
Schluger
Fig. 9/10



JJ-3-5104
Buck
Fig. 11/12



JJ-3-5105
Ochsenbein
Fig. 3



JJ-3-5106
Ochsenbein
Fig. 4



JJ-3-5107
Rhodes
Back - Action
Fig. 36/37

Gingivectomy knives



JJ-3-5115
Goldman-Fox
Fig. 7



JJ-3-5116
Goldman-Fox
Fig. 8



JJ-3-5117
Goldman-Fox
Fig. 9



JJ-3-5118
Goldman-Fox
Fig. 11



JJ-3-5119
Buck
Fig. 3/4



JJ-3-5120
Buck
Fig. 5/6

Curettes and Scalers



JJ-3-5121
Curette
Fig. HU 1/2



JJ-3-5122
Columbia
Fig. 2R/2L



JJ-3-5123
Columbia
Fig. 4R/4L



JJ-3-5124
Columbia
Fig. 13/14



JJ-3-5125
Fig. 411/412



JJ-3-5126
Fig. 413/414



JJ-3-5127
Zerfing-chisel

Gingivectomy knives



JJ-3-5128
Goldman - Fox
Fig. 7



JJ-3-5129
Goldman - Fox
Fig. 8



JJ-3-5130
Goldman - Fox
Fig. 9



JJ-3-5131
Goldman - Fox
Fig. 11



JJ-3-5132
Buck
Fig. 3/4



JJ-3-5133
Buck
Fig. 5/6

Curettes and Scalers



JJ-3-5134
Curette
Fig. HU 1/2



JJ-3-5135
Columbia
Fig. 2R/2L



JJ-3-5136
Columbia
Fig. 4R/4L



JJ-3-5137
Columbia
Fig. 13/14



JJ-3-5138
Fig. 413/412



JJ-3-5139
Fig. 411/414



JJ-3-5140
Zerfing-chisel

Bone Chisels and Gouges



JJ-3-5141
Ochsenbein
Fig. 1

JJ-3-5142
Ochsenbein
Fig. 2

JJ-3-5143
Gardner
Fig. 1

JJ-3-5144
Gardner
Fig. 2

JJ-3-5145
Gardner
Fig. 5

JJ-3-5146
Gardner
Fig. 5R

JJ-3-5147
Gardner
Fig. 6

JJ-3-5148
Wakefield
Fig. 1W

JJ-3-5149
Wakefield
Fig. 2W

JJ-3-5150
Buckley
Fig. 3

Periodontia Instruments and Mallets

Bone Chisels and Gouges

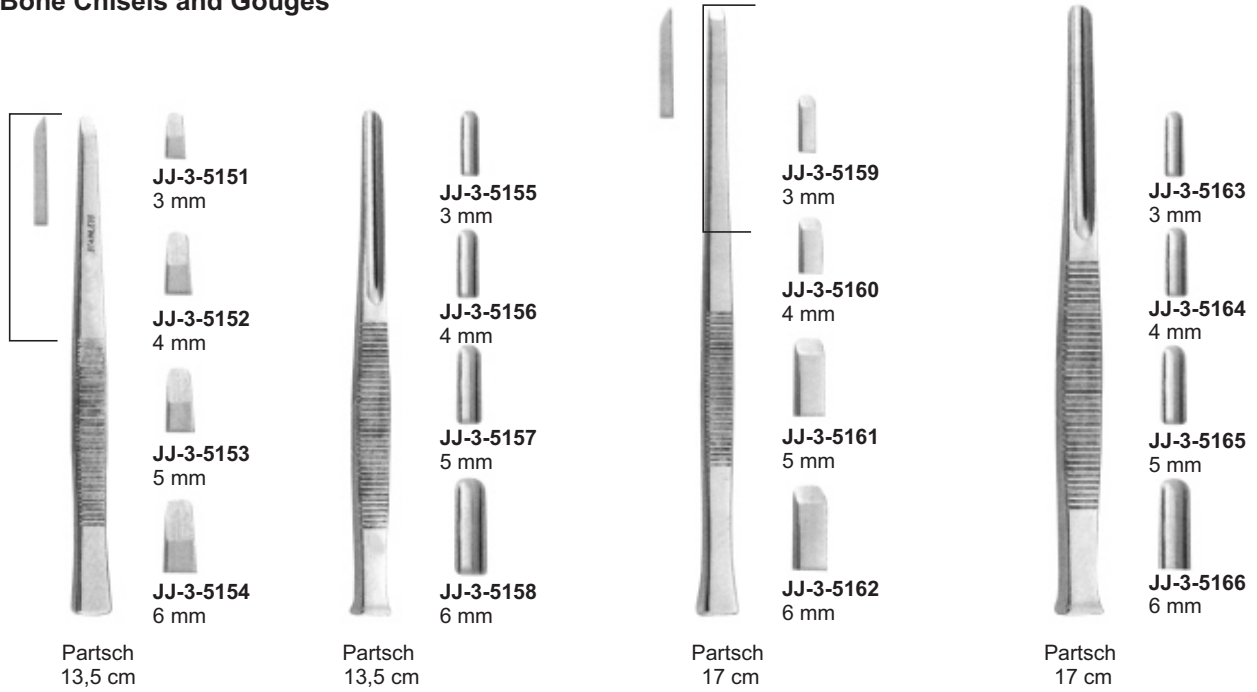

Martelli chirurgici Mallet

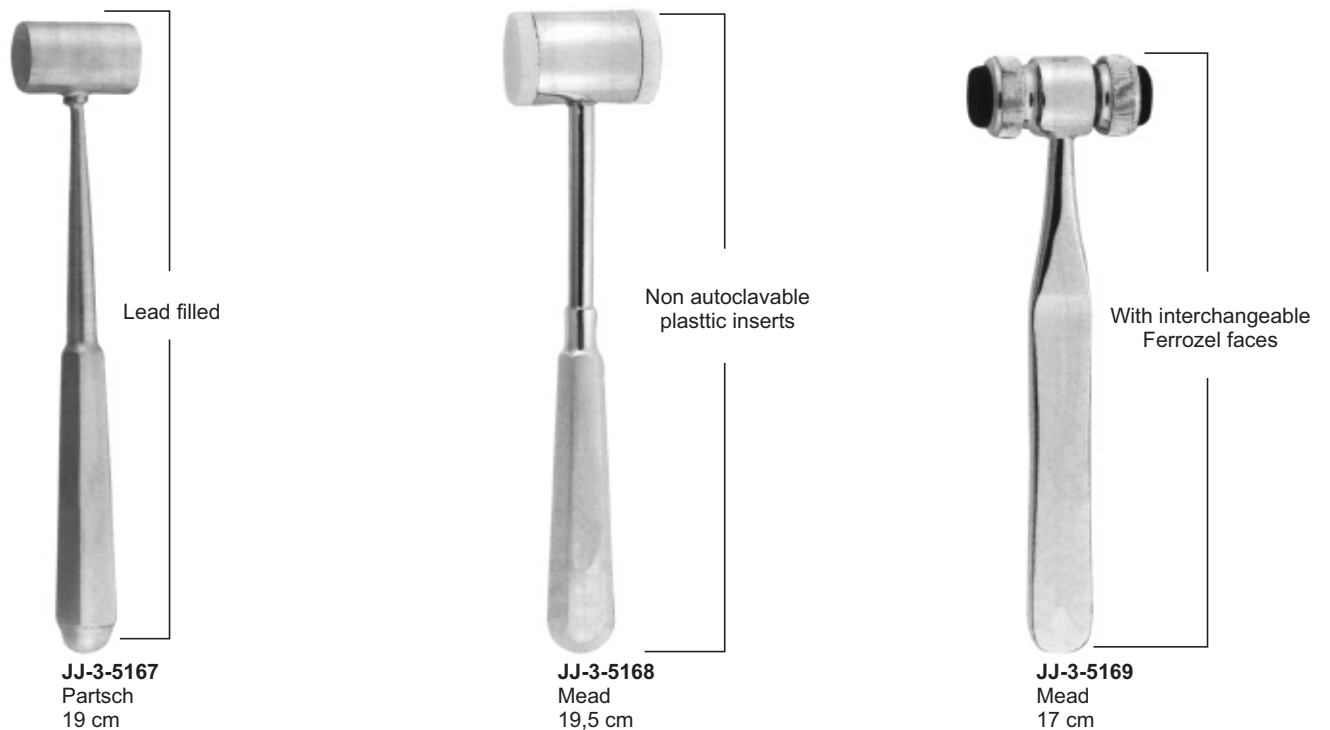

Page
68–74

▪ Currettes Scalers

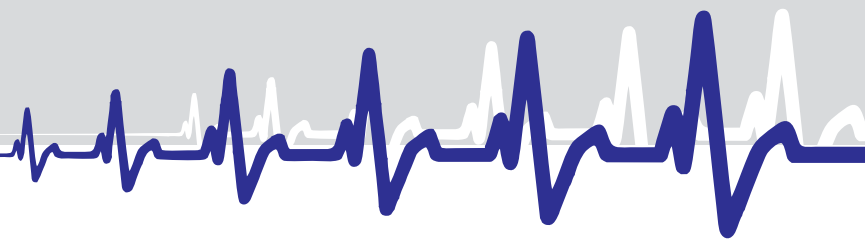

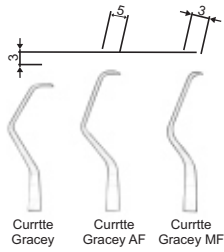

JJ-3-5170
Gracey
Fig. 1/2



JJ-3-5171
Gracey
Fig. 3/4



JJ-3-5172
Gracey
Fig. 5/6



JJ-3-5173
Gracey
Fig. 7/8



JJ-3-5174
Gracey
Fig. 9/10



JJ-3-5175
Gracey
Fig. 11/12



JJ-3-5176
Gracey
Fig. 13/14



JJ-3-5177
Gracey
Mesial Distal
Fig. 11/14



JJ-3-5178
Gracey
Mesial Distal
Fig. 12/13

Gracey Curettes AF Type

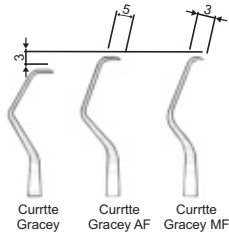

JJ-3-5179
Gracey
AF/type
Fig. 1/2



JJ-3-5180
Gracey
AF/type
Fig. 3/4



JJ-3-5181
Gracey
AF/type
Fig. 5/6



JJ-3-5182
Gracey
AF/type
Fig. 7/8



JJ-3-5183
Gracey
AF/type
Fig. 11/12



JJ-3-5184
Gracey
AF/type
Fig. 13/14



JJ-3-5185
Gracey
AF/type
Fig. 15/16



JJ-3-5186
Gracey
AF/type



JJ-3-5187
Gracey
AF/type
Fig. 1/2



JJ-3-5188
Gracey
AF/type
Fig. 3/4



JJ-3-5189
Gracey
AF/type
Fig. 5/6



JJ-3-5190
Gracey
AF/type
Fig. 7/8



JJ-3-5191
Gracey
AF/type
Fig. 11/12



JJ-3-5192
Gracey
AF/type
Fig. 13/14



JJ-3-5193
Gracey
AF/type
Fig. 15/16



JJ-3-5194
Gracey
MF/type
Fig. 1/2



JJ-3-5195
Gracey
MF/type
Fig. 3/4



JJ-3-5196
Gracey
MF/type
Fig. 5/6



JJ-3-5197
Gracey
MF/type
Fig. 7/8



JJ-3-5198
Gracey
MF/type
Fig. 11/12



JJ-3-5199
Gracey
MF/type
Fig. 13/14



JJ-3-5200
Gracey
MF/type
Fig. 15/16

Gracey Curettes AF Type

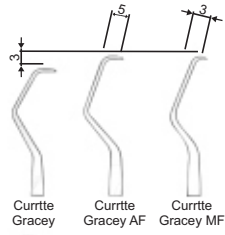

JJ-3-5201
Gracey
MF/type
Fig. 1/2



JJ-3-5202
Gracey
MF/type
Fig. 3/4



JJ-3-5203
Gracey
MF/type
Fig. 5/6



JJ-3-5204
Gracey
MF/type
Fig. 7/8



JJ-3-5205
Gracey
MF/type
Fig. 11/12



JJ-3-5206
Gracey
MF/type
Fig. 13/14



JJ-3-5207
Gracey
MF/type
Fig. 15/16



JJ-3-5208
Goldman - Fax
Fig. 1



JJ-3-5209
Goldman - Fax
Fig. 2



JJ-3-5210
Goldman - Fax
Fig. 3



JJ-3-5211
Goldman - Fax
Fig. 4



JJ-3-5212
Goldman - Fax
Fig. 21

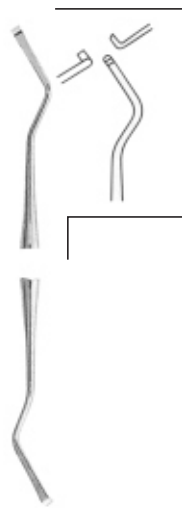

JJ-3-5213
Goldman - Fax
Fig. 5



JJ-3-5214
Mc Call
Fig. 13S/14S

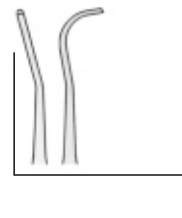

JJ-3-5215
Younger-Good
Fig. 7/8

Curettes and Scalers

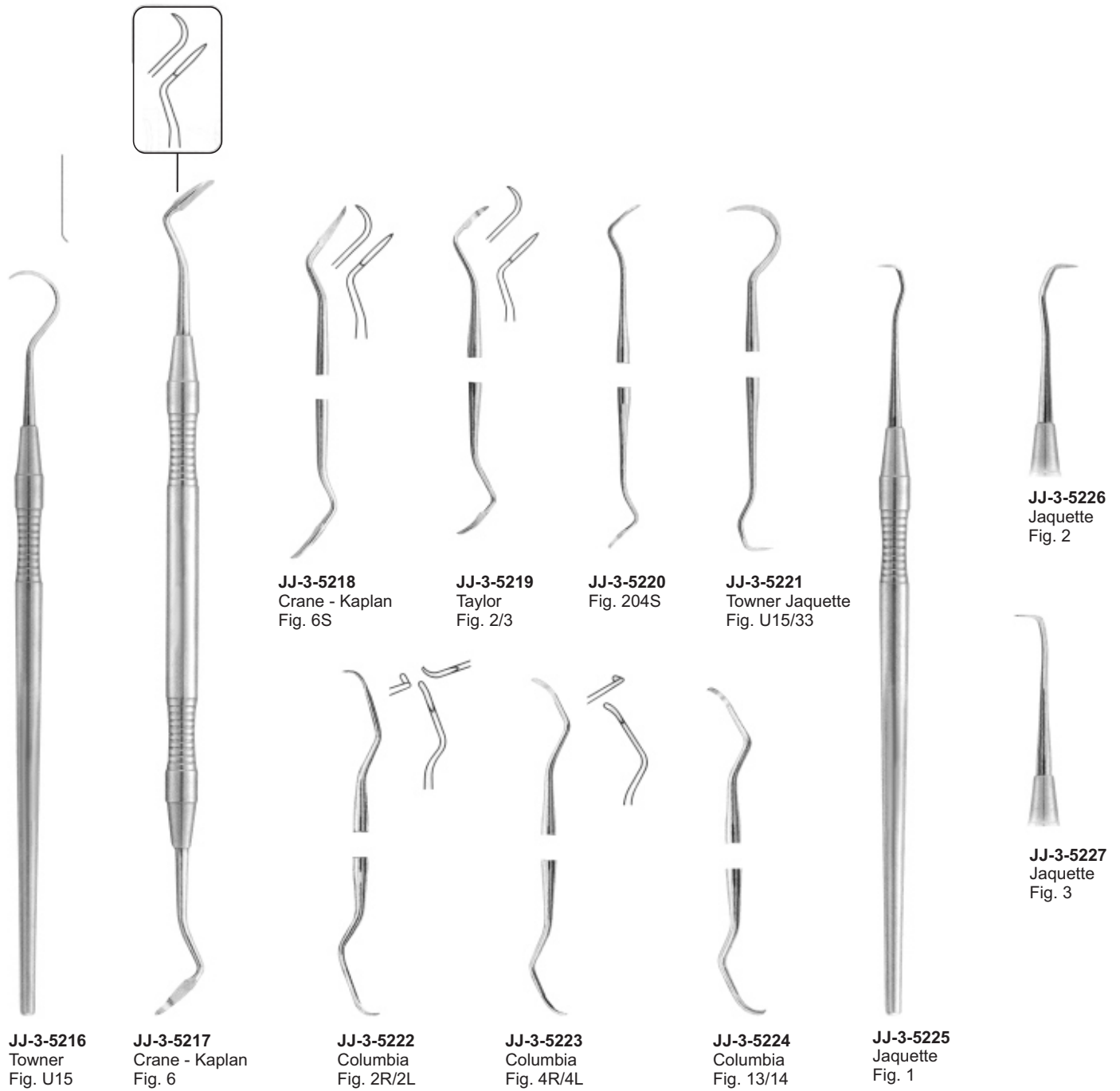

JJ-3-5216
Towner
Fig. U15

JJ-3-5217
Crane - Kaplan
Fig. 6

JJ-3-5218
Crane - Kaplan
Fig. 6S

JJ-3-5219
Taylor
Fig. 2/3

JJ-3-5220
Fig. 204S

JJ-3-5221
Towner Jaquette
Fig. U15/33

JJ-3-5226
Jaquette
Fig. 2

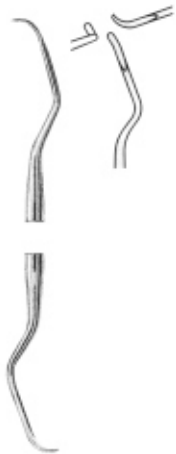

JJ-3-5222
Columbia
Fig. 2R/2L

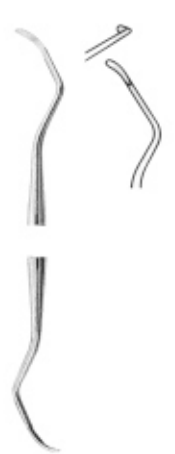

JJ-3-5223
Columbia
Fig. 4R/4L



JJ-3-5224
Columbia
Fig. 13/14



JJ-3-5225
Jaquette
Fig. 1



JJ-3-5227
Jaquette
Fig. 3



JJ-3-5228
Hemingway
Fig. 1



JJ-3-5229
Hemingway
Fig. 2



JJ-3-5230
Hemingway
Fig. 3



JJ-3-5231
Lucas
Fig. 85



JJ-3-5232
Lucas
Fig. 86



JJ-3-5233
Lucas
Fig. 87

Page 75–77

- Modelling Instruments & Measuring Instruments

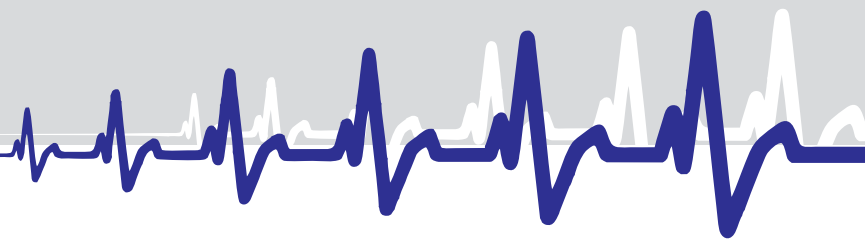

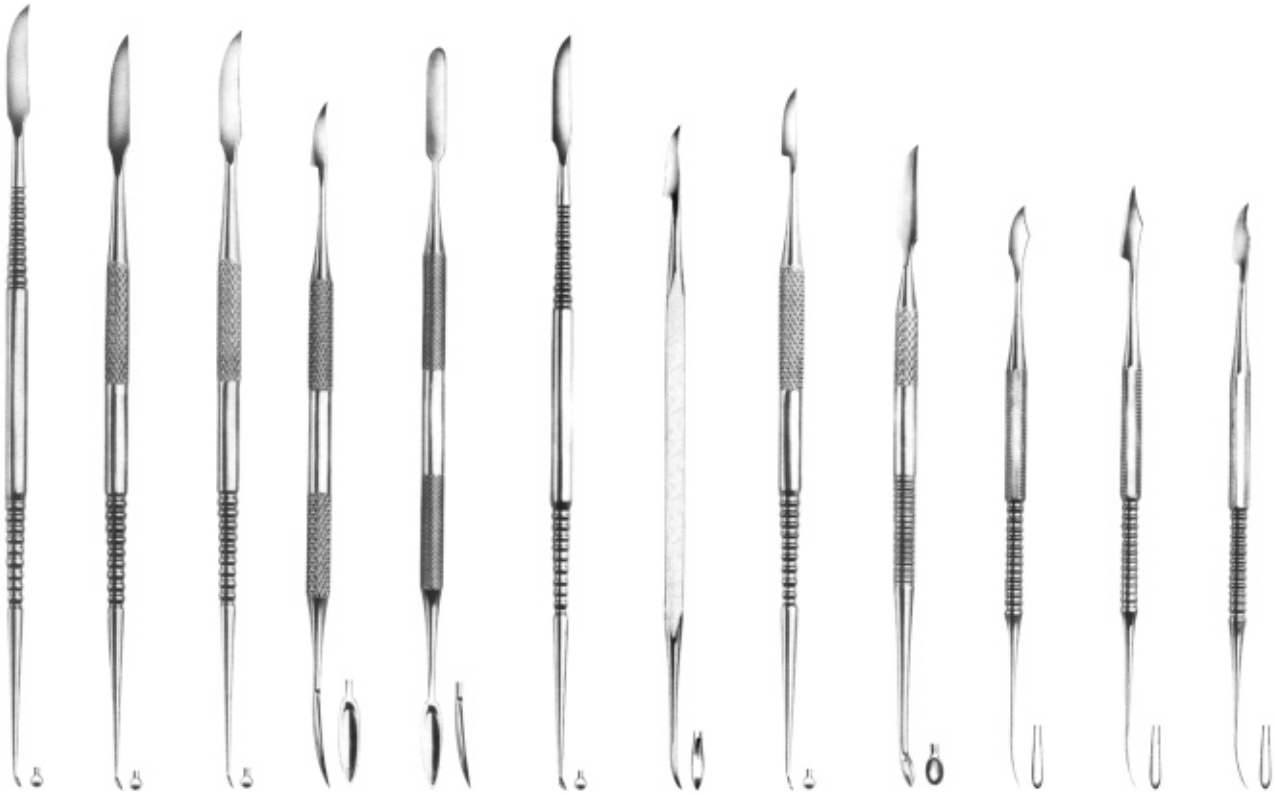

JJ-4-5101 Le Cron
JJ-4-5102 Le Cron
JJ-4-5103 Le Cron
JJ-4-5104 MSY
JJ-4-5105 MSY
JJ-4-5106 Le Cron
JJ-4-5107 Hylin
JJ-4-5108 Hylin
JJ-4-5109 Hylin
JJ-4-5110 Zahle
JJ-4-5111 Zahle
JJ-4-5112 Zahle

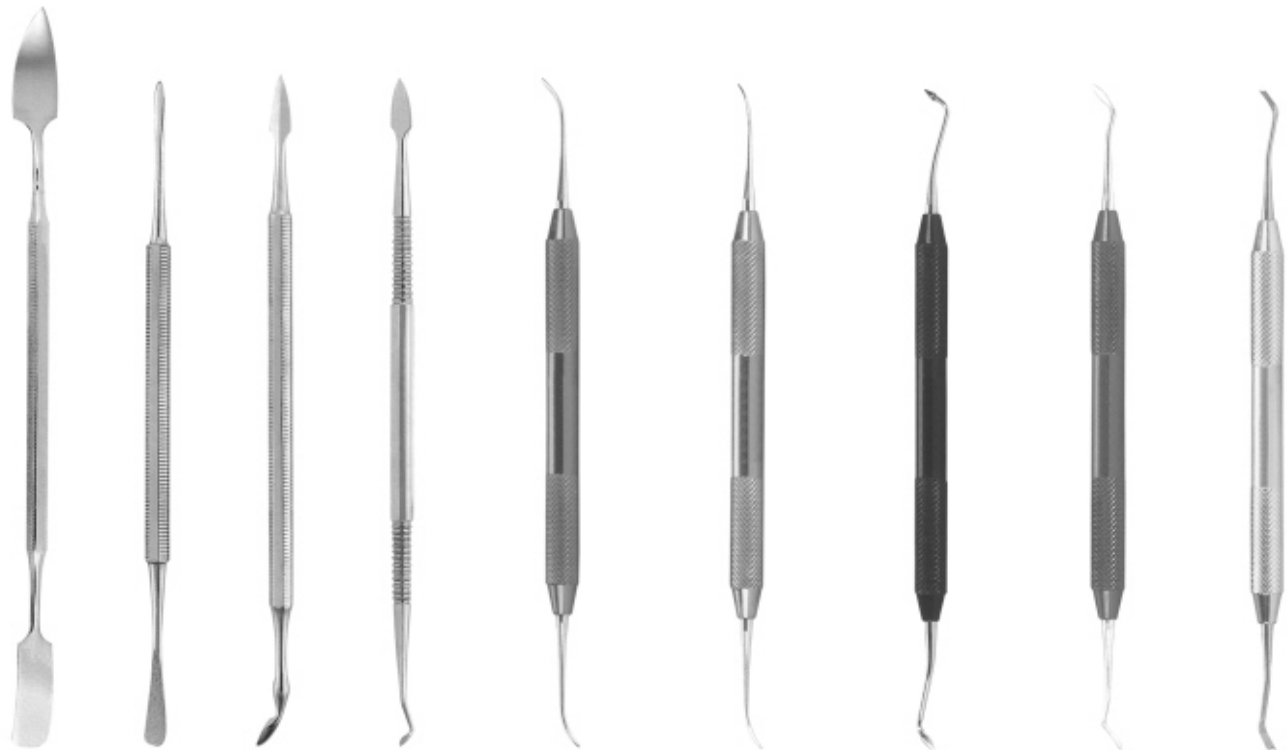

JJ-4-5113 Gritman
JJ-4-5114 Beale
JJ-4-5115 Roach
JJ-4-5116 Vehe
JJ-4-5117 P.K. Thomas Fig. 1
JJ-4-5118 P.K. Thomas Fig. 2
JJ-4-5119 P.K. Thomas Fig. 3
JJ-4-5120 P.K. Thomas Fig. 4
JJ-4-5121 P.K. Thomas Fig. 5

Measuring Instruments



JJ-4-5122
Boley



JJ-4-5123
Zuricher
130 mm



JJ-4-5124
Vernier
12 cm



JJ-4-5125
Vernier

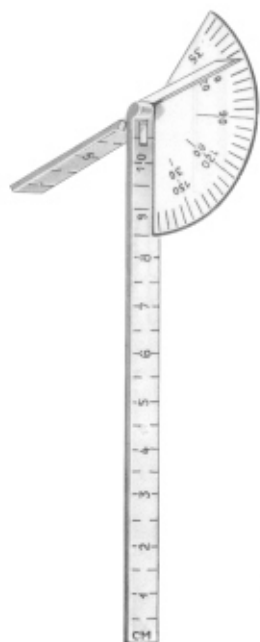

JJ-4-5126
Caroll



JJ-4-5127
Castroviejo's
Scleral Marker



JJ-4-5128
Iwanson

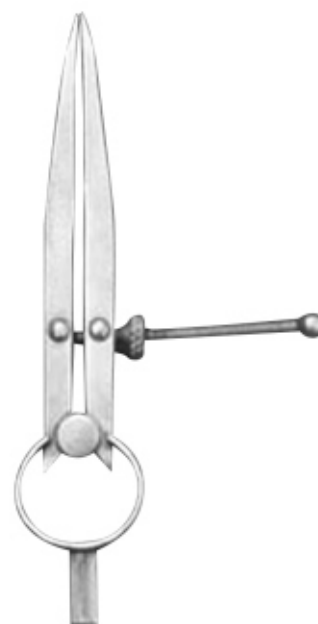

JJ-4-5129
Albee



JJ-4-5130
18 cm
7 1/8"



JJ-4-5131
18 cm
7 1/8"



JJ-4-5132
17 cm
6 3/4"
Gritman

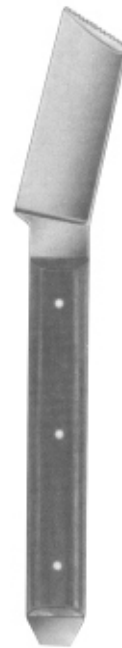

JJ-4-5133
17 cm
6 3/4"
Medicon



JJ-4-5134
22 cm
8 3/4"



JJ-4-5135
Antkoviak



JJ-4-5136
Ermert



JJ-4-5137
Ermert

Page
78–79

▪ Wax Knives/plaster



Wax Knives



JJ-4-5138
Fahnenstock
Fig. 1
12,5cm



JJ-4-5139
Fahnenstock
Fig. 2
17cm



JJ-4-5140
Lessmann
Fig. 1
12,5cm



JJ-4-5141
Lessmann
Fig. 2
17cm



JJ-4-5142
Con scodellino
Fig. 1
12,5cm



JJ-4-5143
Con scodellino
Fig. 2
17cm

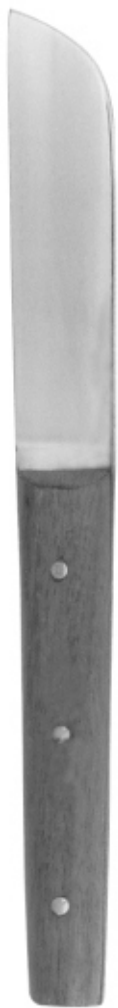

JJ-4-5144
Fig. 1
17 cm



JJ-4-5145
Gritman
Fig. 2
17 cm



JJ-4-5146
Fig. 3
16 cm



JJ-4-5147
Fig. 4
16 cm

Page 80–85

▪ Diagnostic, Explorer, Endodontic Instruments

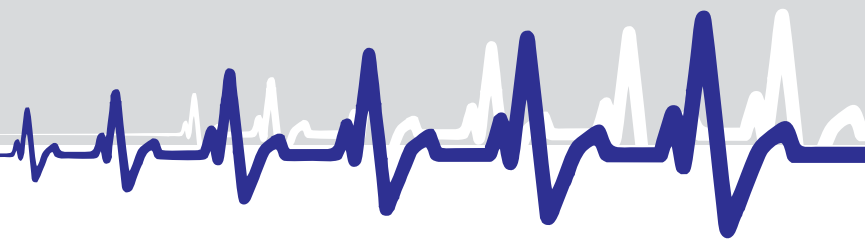

Explorers



JJ-4-5148
Fig 23



JJ-4-5149
Fig 6



JJ-4-5150
Fig 8



JJ-4-5151
Fig 9



JJ-4-5152
Fig 17



JJ-4-5153
Fig 3
Rein



JJ-4-5154
Fig 23/17



JJ-4-5155
Fig 17

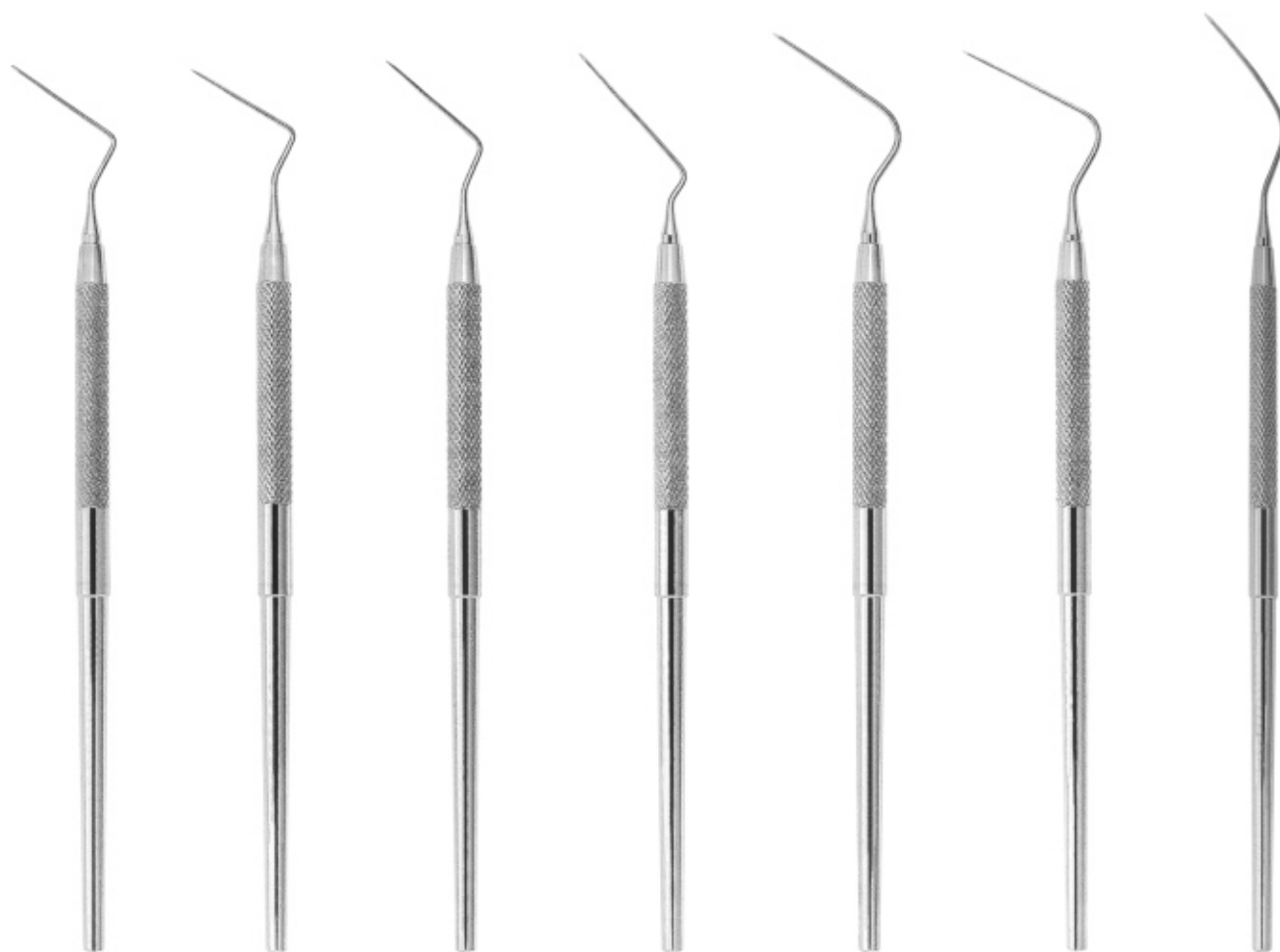

JJ-4-5156
Fig.1
Spreader

JJ-4-5157
Fig.2
Spreader

JJ-4-5158
Fig.3
Spreader

JJ-4-5159
Fig.4
Spreader

JJ-4-5110
Fig.5
Spreader

JJ-4-5111
Fig.6
Spreader

JJ-4-5112
Fig.7
Spreader

Endodontic Instruments

Double-Ended Root CaAll Explorers Plugger/Spreaders

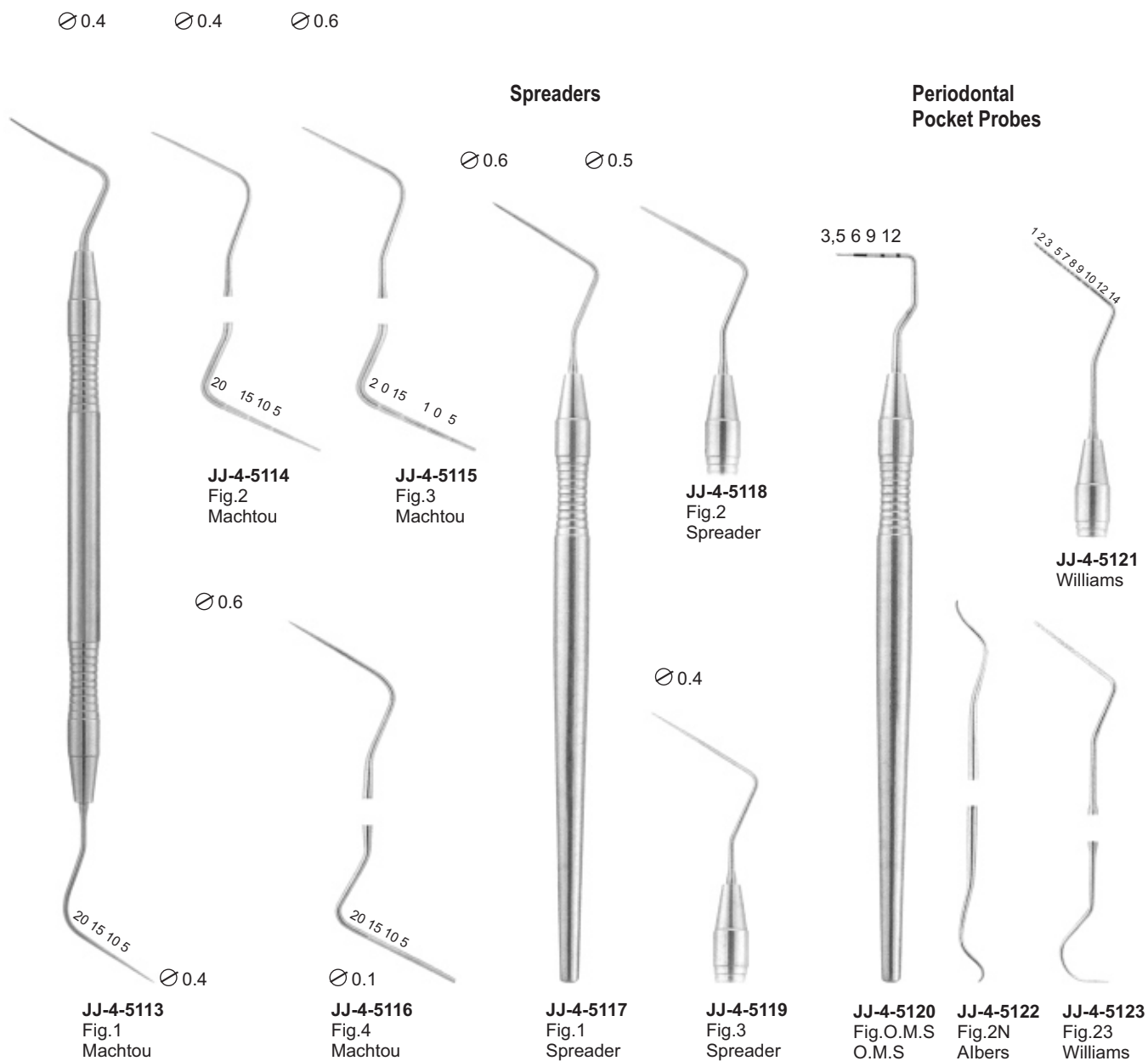

Root-caAll pluggers

Ø 0.5



JJ-4-5124
Fig.1
Luks

Ø 0.7



JJ-4-5125
Fig.2
Luks

Ø 0.9



JJ-4-5126
Fig.3
Luks

Ø 1.1



JJ-4-5127
Fig.4
Luks

Ø 0.5



JJ-4-5128
Fig.1
Vertical
condenser

Ø 0.7



JJ-4-5129
Fig.2
Vertical
condenser

Ø 0.9



JJ-4-5130
Fig.3
Vertical
condenser

Ø 1.1



JJ-4-5131
Fig.4
Vertical
condenser

Endodontic set



JJ-4-5132
Measuring Plate

Endodontic Instruments

Root-caAll pluggers

Optimum Flexibility
Very Fine Points

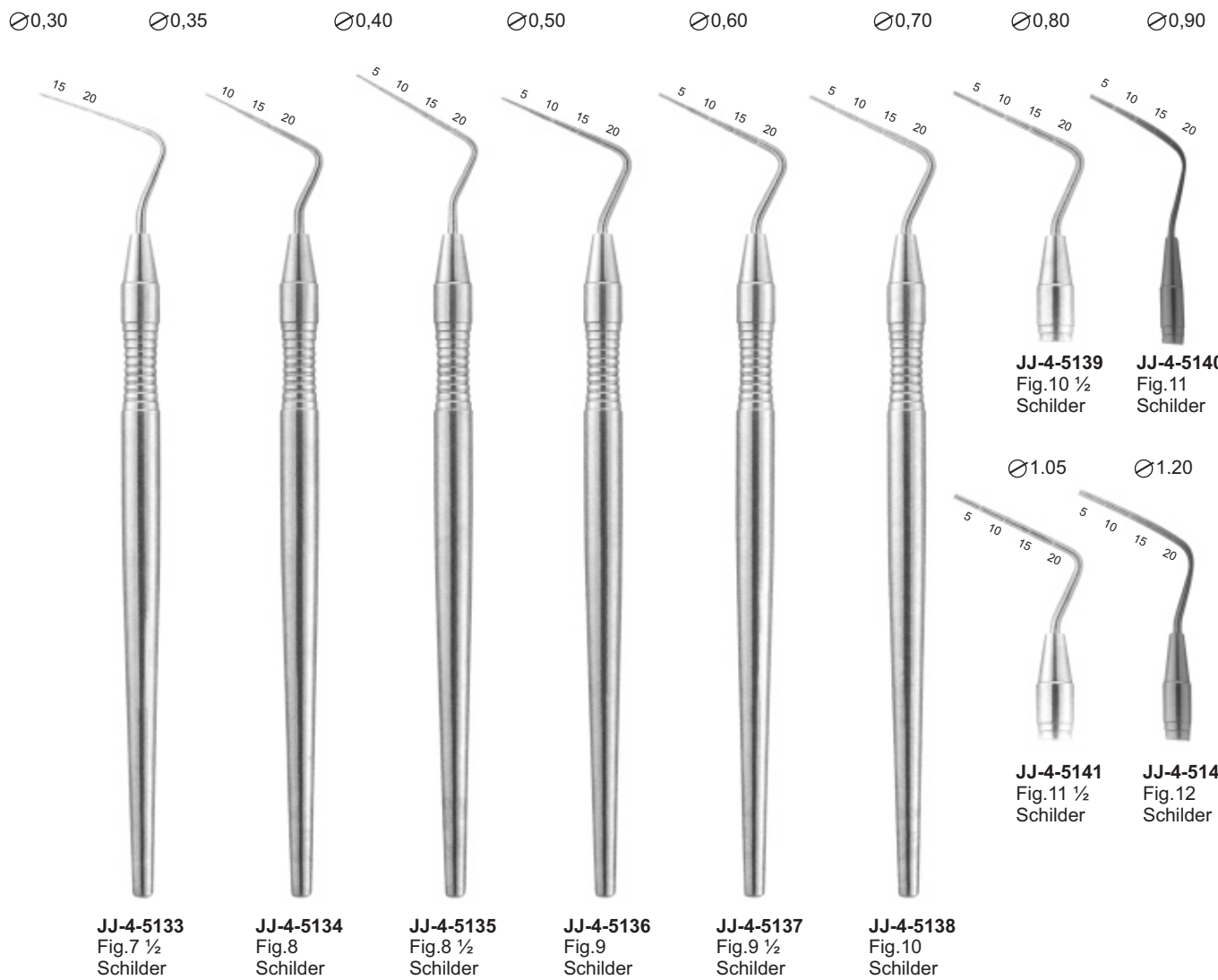

Root-caAll explorers

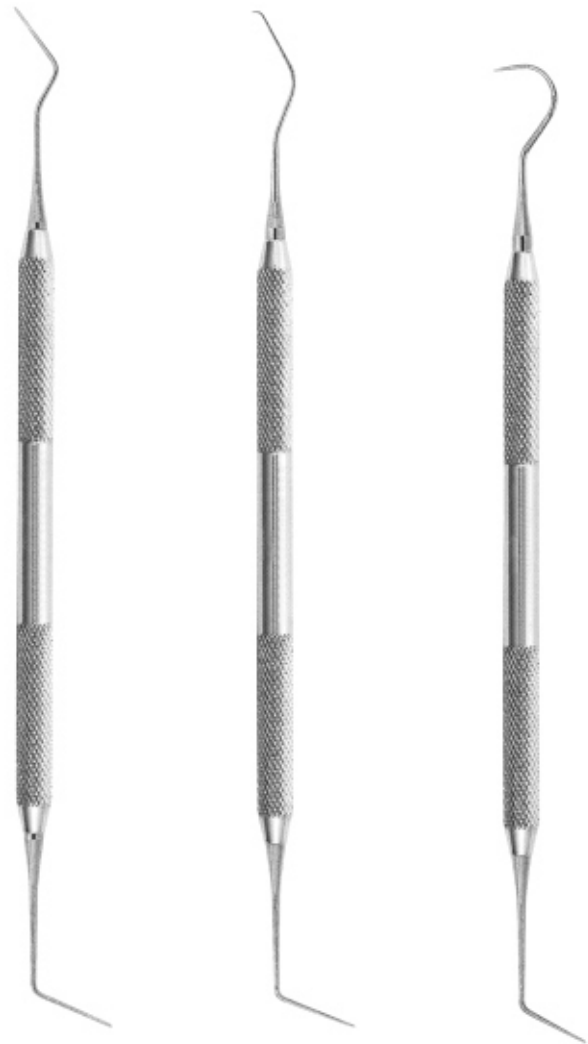

JJ-4-5143
Fig.6/1

JJ-4-5144
Fig.6/17

JJ-4-5145
Fig.6/23

Root-caAll excavators



JJ-4-5146
Fig.31L

JJ-4-5147
Fig.32L

JJ-4-5148
Fig.33L

Page 86-87

- Excavators

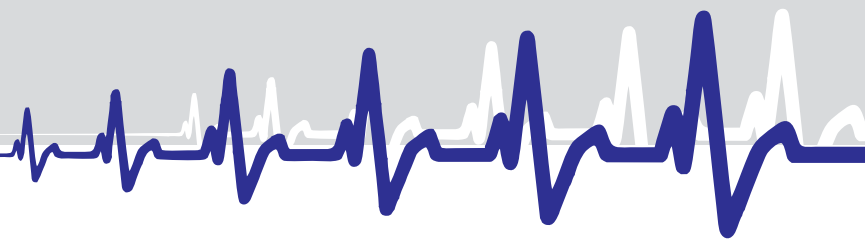

Excavators

1 mm



JJ-4-5149
Fig 5

1.2 mm



JJ-4-5150
Fig 14

1 mm



JJ-4-5151
Fig 17

1.2 mm



JJ-4-5152
Fig 18

1.6 mm



JJ-4-5153
Fig 19

2 mm



JJ-4-5154
Fig 20

1 mm



JJ-4-5155
ASH
Fig.243

1,4 mm



JJ-4-5156
ASH
Fig.G2

0,8 mm



JJ-4-5157
Fig.1

0,8 mm



JJ-4-5158
Fig.2

1 mm



JJ-4-5159
Fig.11

1 mm



JJ-4-5160
Fig.12

1,2 mm



JJ-4-5161
Fig.21

1,2 mm



JJ-4-5162
Fig.22

1,6 mm



JJ-4-5163
Fig.31

1,6 mm



JJ-4-5164
Fig.32

2 mm



JJ-4-5165
Fig.41

2 mm



JJ-4-5166
Fig.42

Page 88–89

- Handles For Mouth Mirrors

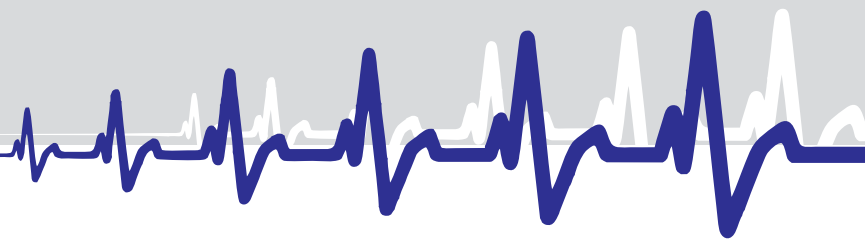

Plane



JJ-5-5104
Fig.6
Ø 26 mm



JJ-5-5105
Fig.5
Ø 24 mm



JJ-5-5106
Fig.4
Ø 22 mm



JJ-5-5107
Fig.4
Rhodium
Ø 22 mm

Front surface
mouth mirrors

Set of 5 pieces



JJ-5-5101



JJ-5-5102



JJ-5-5103

Hollow,
stainless
steel

Magnifying



JJ-5-5108
Fig.6
Ø 26 mm



JJ-5-5109
Fig.5
Ø 24 mm



JJ-5-5110
Fig.4
Ø 22 mm



JJ-5-5111
Fig.5
Rhodium
Ø 24 mm

Handles for Mouth Mirrors and Mouth Mirrors



JJ-5-5112



JJ-5-5113



JJ-5-5114



JJ-5-5115



JJ-5-5116



JJ-5-5117
Parallelometer
mouth mirror



JJ-5-5118
Parallelometer
mouth mirror
+ handle
code 2101

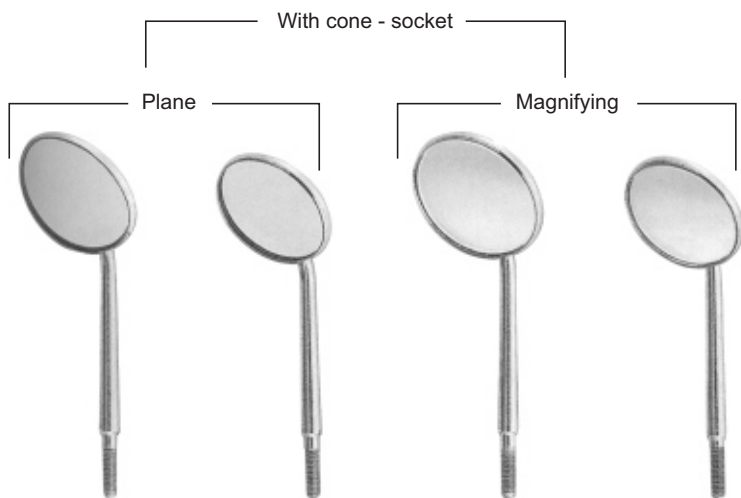

JJ-5-5119
Fig.5
Ø24 mm

JJ-5-5120
Fig.4
Ø22 mm

JJ-5-5121
Fig.5
Ø 24 mm

JJ-5-5122
Fig.4
Ø 22 mm



JJ-5-5123
Cone - socket



JJ-5-5124
Cone - socket



JJ-5-5125
Cone - socket

Page
90–93

- Spatulas

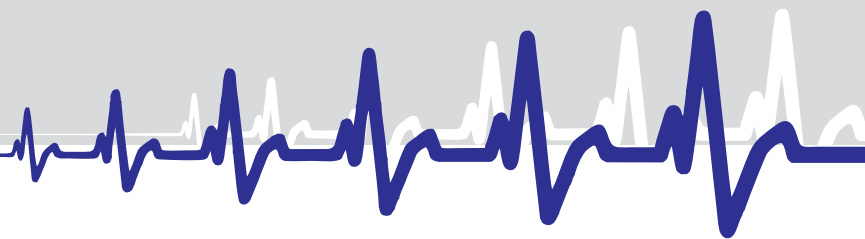



JJ-5-5126



JJ-5-5127



JJ-5-5128



JJ-5-5129

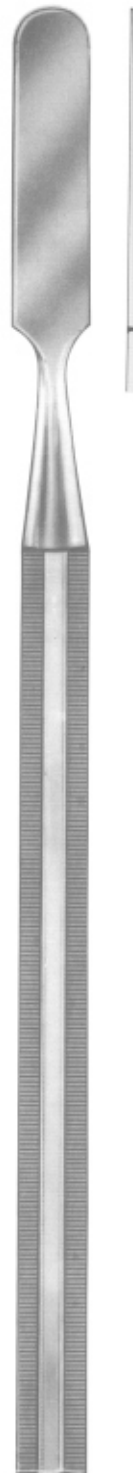

JJ-5-5130



JJ-5-5131



JJ-5-5132



JJ-5-5133

Cement Spatulas

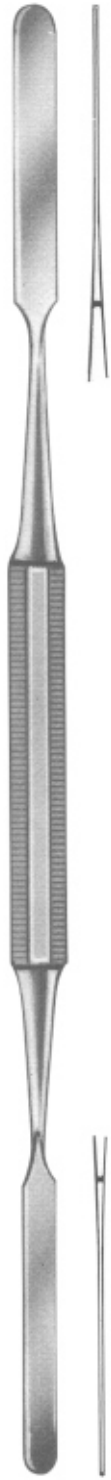

JJ-5-5134

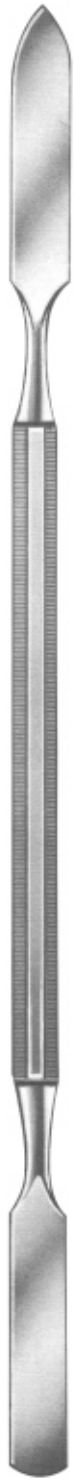

JJ-5-5135



JJ-5-5136

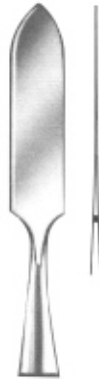

JJ-5-5137



JJ-5-5138



JJ-5-5139



JJ-5-5140



JJ-5-5136



JJ-5-5137



JJ-5-5138



JJ-5-5139



JJ-5-5140



Spatulas for Plaster and AlgiAlte



Page 94-100

- Needle Holders

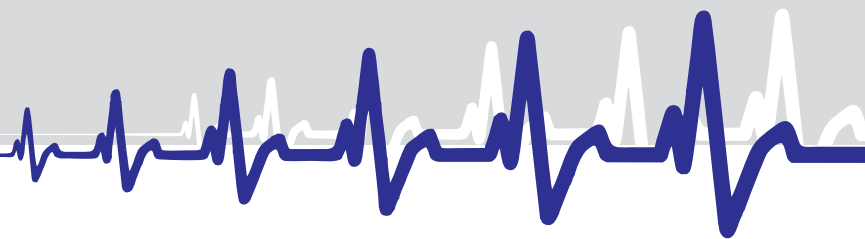



JJ-5-5150
Mayo-Hegar
16 cm



JJ-5-5151
Mayo-Hegar TC
16 cm



JJ-5-5152
Mayo-Hegar
18 cm



JJ-5-5153
Mayo-Hegar TC
18 cm



JJ-5-5154
Mini-Ryder
18 cm



JJ-5-5155
Mini-Ryder
15 cm



JJ-5-5156
Derf
12 cm



JJ-5-5157
Hegar-Baumgarther
14 cm

Needle Holders



JJ-5-5158
Crile-Wood
15 cm



JJ-5-5159
Crile-Wood TC
15 cm



JJ-5-5160
Adson
17.5 cm



JJ-5-5161
Olsen-Hegar
14 cm



JJ-5-5162
Baumgarther
14.5 cm



JJ-5-5163
Gillies
16 cm



JJ-5-5164
Gillies
16 cm



JJ-5-5165
Hegar-Baumgarther
14 cm



JJ-5-5166
Toennis
18 cm



JJ-5-5167
Toennis
18 cm



JJ-5-5168
Lichtenberg
17 cm



JJ-5-5169
Lichtenberg
17 cm



JJ-5-5170
Eiselberg-Mathieu
19.5 cm



JJ-5-5171
Boynton
12 cm



JJ-5-5172
Arruga
16 cm



JJ-5-5173
Boynton
12 cm



JJ-5-5174
Arruga
16 cm

Needle Holders



JJ-5-5175
Castroviejo
14 cm



JJ-5-5176
Castroviejo
14 cm



JJ-5-5177
Castroviejo
14/60 cm



JJ-5-5178
Castroviejo
18 cm



JJ-5-5179
Castroviejo
18 cm



JJ-5-5180
Castroviejo
14 cm



JJ-5-5181
Castroviejo
14 cm



JJ-5-5182
Castroviejo
14/60 cm



JJ-5-5183
Castroviejo
18 cm



JJ-5-5184
Castroviejo
18 cm



JJ-5-5185
Mathieu
14 cm



JJ-5-5186
Mathieu
14 cm



JJ-5-5187
Mathieu
14 cm



JJ-5-5188
Mathieu
14 cm



JJ-5-5189
Mathieu
17 cm



JJ-5-5190
Mathieu
17 cm



JJ-5-5191
Mathieu
14 cm



JJ-5-5192
Micro-Barraquer
18 cm

Needle Holders & Stainless Steel Saliva Ejectors



The tips have tungsten carbide inserts for better handling.



JJ-5-5193
Mathieu
17 cm



JJ-5-5194
Mathieu
17 cm



JJ-5-5195
Micro-Barraquer
14 cm



JJ-5-5196
Castroviejo
13 cm



JJ-5-5197
Castroviejo-Barraquer
13 cm



JJ-5-5198
Castroviejo
13 cm



JJ-5-5199
Castroviejo
13 cm



JJ-5-5200
18.03mm,cm



JJ-5-5201
18.04mm,cm



JJ-5-5202
18.05mm,cm



JJ-5-5206
Fig.6FR
Fraizer
15.02mm,cm



JJ-5-5203
Fig.12FR
Fraizer
15.04mm,cm



JJ-5-5204
Fig.10FR
Fraizer
15.03,3mm,cm



JJ-5-5205
Fig.8FR
Fraizer
15.02,7mm,cm

0.4 **JJ-5-5207**
12.5 cm

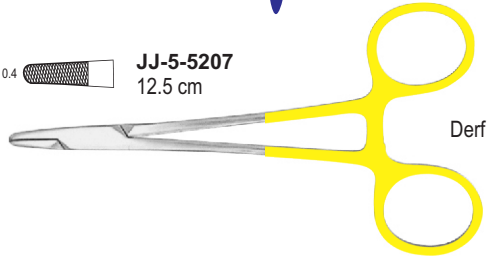

Derf

0.4 **JJ-5-5214**
14 cm

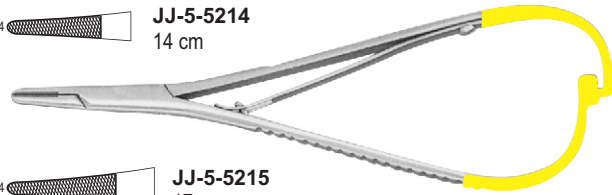

Mathieu
Kocher

0.4 **JJ-5-5208**
13 cm

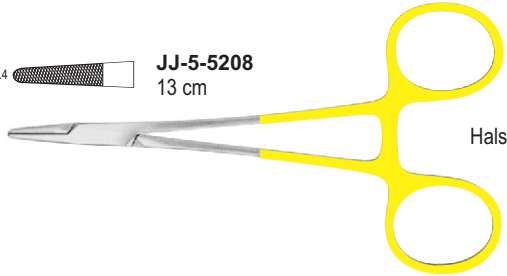

Halsey

0.4 **JJ-5-5215**
17 cm

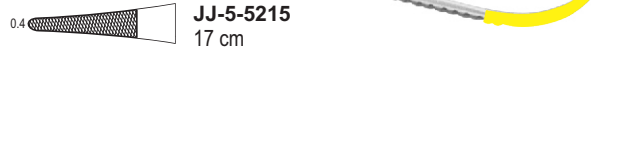

Mathieu

0.5 **JJ-5-5209**
14.5 cm

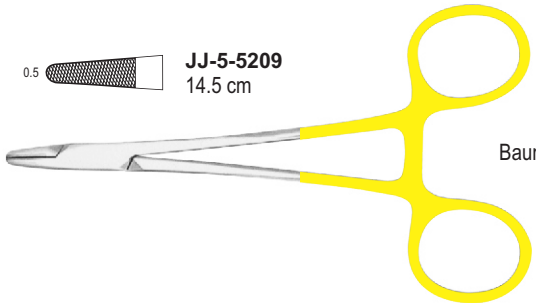

Baumgartner

0.4 **JJ-5-5216**
14 cm

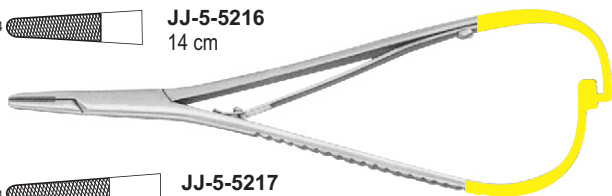

Mathieu

0.4 **JJ-5-5217**
17 cm

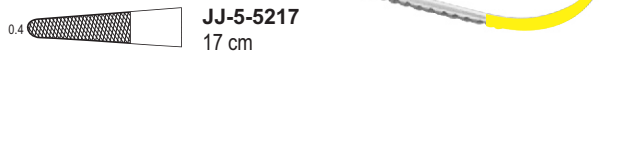

0.4 **JJ-5-5218**
14 cm

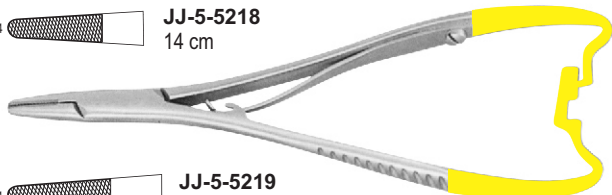

0.4 **JJ-5-5219**
17 cm

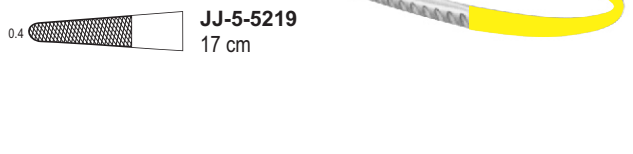

0.4 **JJ-5-5210**
15 cm

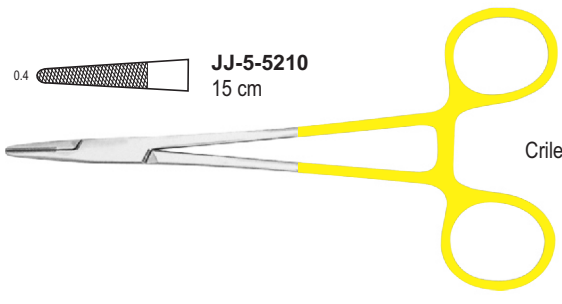

Crilewood

0.4 **JJ-5-5220**
14 cm

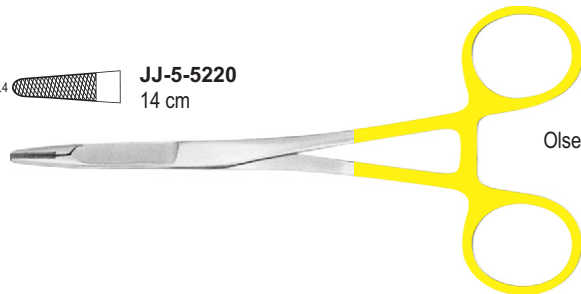

Olsen-Hegar

0.4 **JJ-5-5211**
15 cm

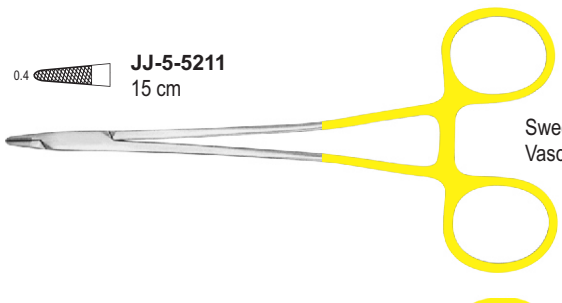

Swedish-Micro
Vascular

0.5 **JJ-5-5212**
16 cm

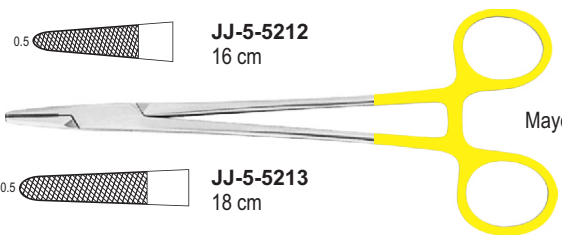

Mayo-Hegar

0.5 **JJ-5-5221**
18 cm



Toennis

0.5 **JJ-5-5213**
18 cm

Page 101-109

- Syringes and Scissors

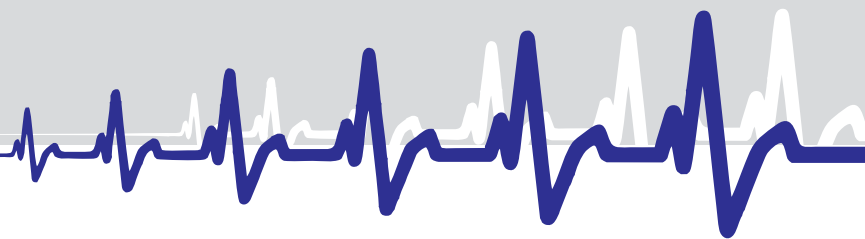

Water Syringes



JJ-5-5222

Water Syringe complete with
1 cannula (Lure-Lock)



JJ-5-5223

Water Syringe complete with
1 cannula (Lure-Lock)



JJ-5-5224

Metal water syringe, self-filling,
with 1 cannula (Lure-Lock)



JJ-5-5225

Sparrel Barrel with
plunger suitable for
syringes



JJ-5-5226

Cannula, only, with
Luer-Lock connector
suitable for syringes



JJ-5-5227
Aspirating Syringe

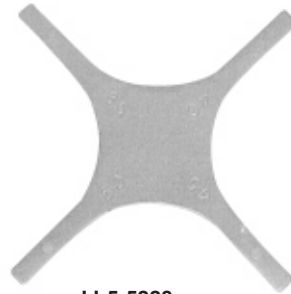

JJ-5-5228
Position Gauge

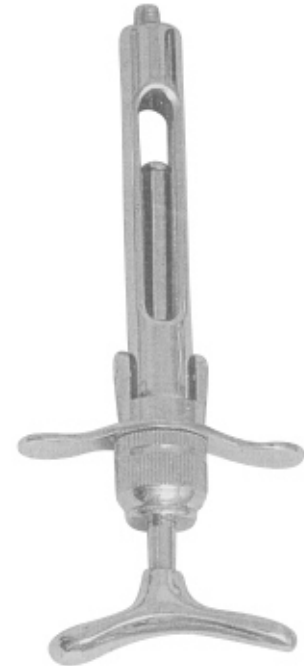

JJ-5-5229
Breech Loading Syringe



JJ-5-5230
Aspirating & Breech Syringe



JJ-5-5231
Band Adaptor



JJ-5-5232
Endo Finger Ruler
With Adjustable Slide

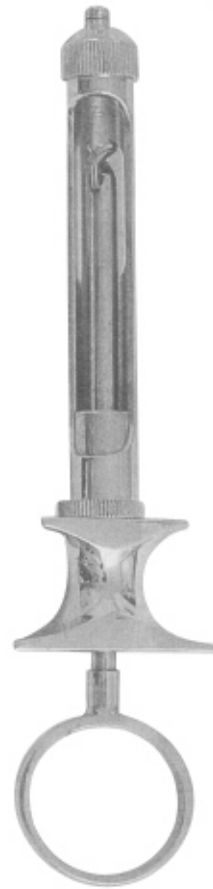

JJ-5-5233
Aspirating Syringe

Dental Syringes



JJ-5-5234



JJ-5-5236



JJ-5-5235



JJ-5-5239
Tip Only, short



JJ-5-5241



JJ-5-5240
Tip Only, long

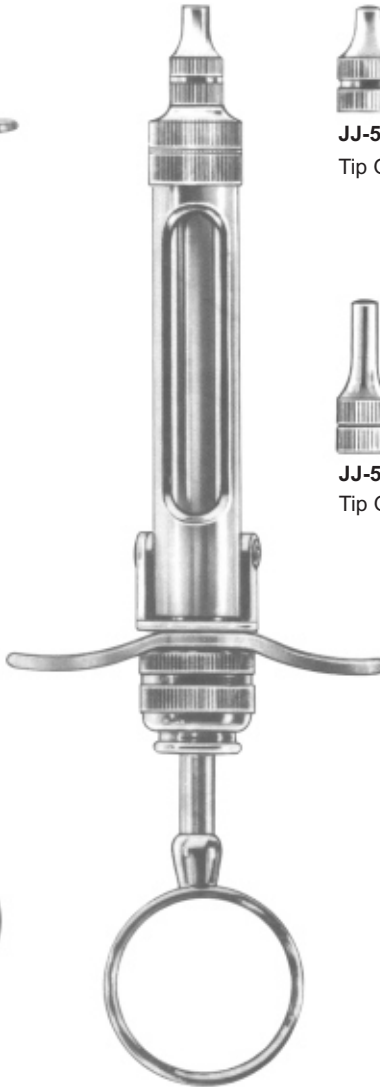

JJ-5-5237 1,8 ml
JJ-5-5238 2,2 ml

Cartridge Syringe complete
With 2 tips and without needles



JJ-5-5242



JJ-5-5243



JJ-5-5244
Cork screw tip



JJ-5-5245
Cork screw tip



JJ-5-5246
Folding type, cork
screw tip



JJ-5-5247
Folding type, cork
screw tip



JJ-5-5248



JJ-5-5249
Cork screw tip



JJ-5-5250
Spare cap with
metric thread



JJ-5-5251
With Whitworth
thread



JJ-5-5252
Autoclavable Plastic Protection sleeve



JJ-5-5253
Brass syringe with stainless steel moving parts



JJ-5-5254
Brass syringe with stainless
steel moving parts

Operating Scissors

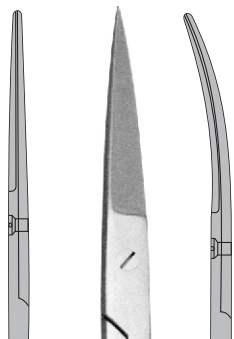

JJ-5-5255
11.5 cm
JJ-5-5256
13 cm
JJ-5-5257
14 cm



Standard
Sharp / Sharp

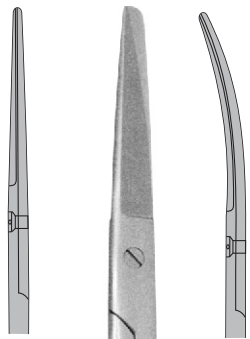

JJ-5-5261
11.5 cm
JJ-5-5262
13 cm
JJ-5-5263
14 cm



Standard
Blunt / Sharp

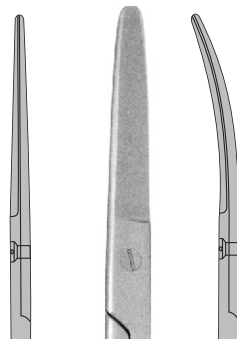

JJ-5-5267
11.5 cm
JJ-5-5268
13 cm
JJ-5-5269
14 cm



Standard
Blunt / Blunt

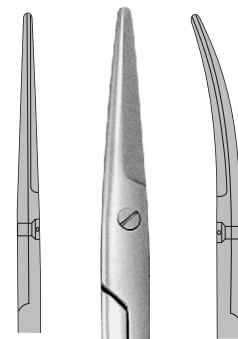

JJ-5-5273 **JJ-5-5274**



Mayo
14.5 cm

Suture Scissors / Tijeras para Hilos / Pliers

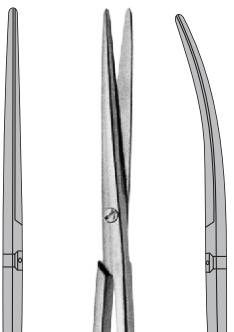

JJ-5-5275



Metzenbaum-Delicate
14.5 cm



JJ-5-5276 **JJ-5-5277**



Metzenbaum
14.5 cm

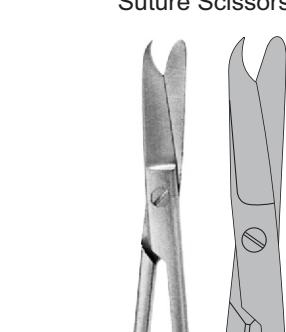

JJ-5-5279
Littauer
14 cm

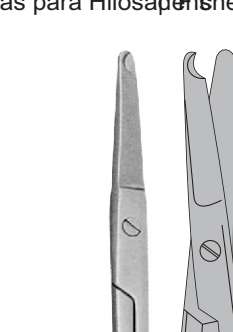

Spencer
JJ-5-5280 9 cm
JJ-5-5281 13 cm



Bandage Scissors Lister
JJ-5-5282 9 cm
JJ-5-5283 11 cm
JJ-5-5284 14 cm
JJ-5-5285 18 cm



Iris
11.5 cm

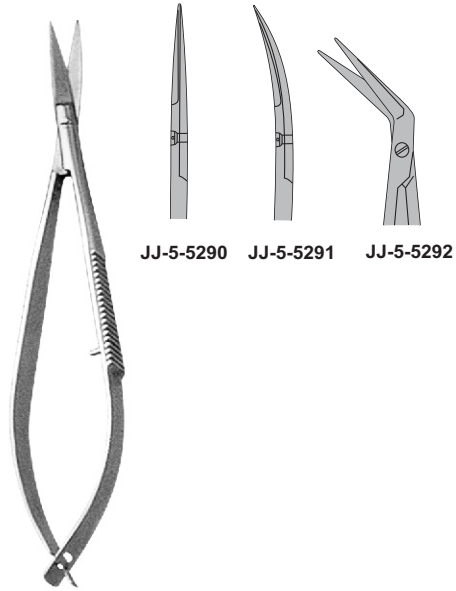

Noyes / Castroviejo
12 cm

JJ-5-52903
La Grange
11.5 cm



JJ-5-5294
Universal
18 cm

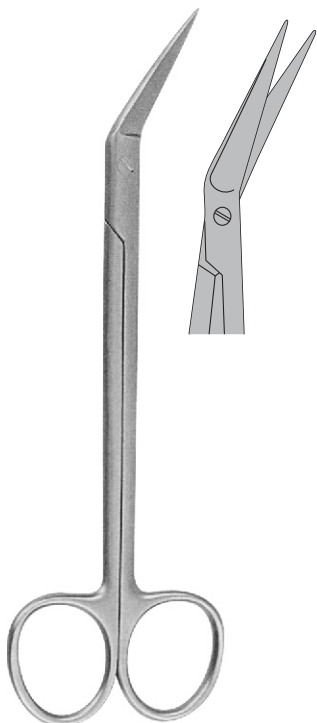

JJ-5-5295
Kelly
16 cm

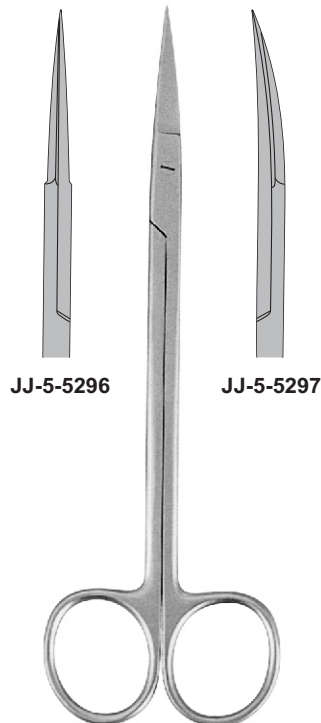

Kelly
16 cm



JJ-5-5298
Goldman-Fox
13 cm

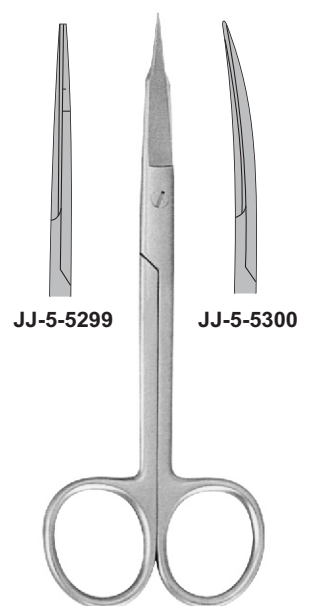

Goldman-Fox
13 cm

Scissors

Scissors, One Blade Serrated

- One blade is with fine serrations to avoid tissue or ligature slippage.
- Manufactured from high quality stainless steel to provide longer-lasting cutting edge.
- Single black ring for easy identification.

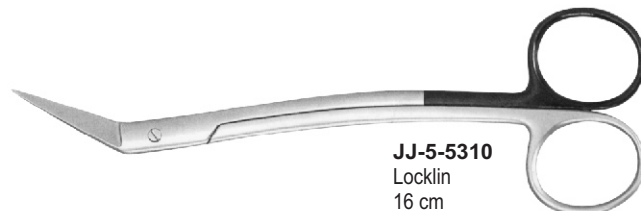
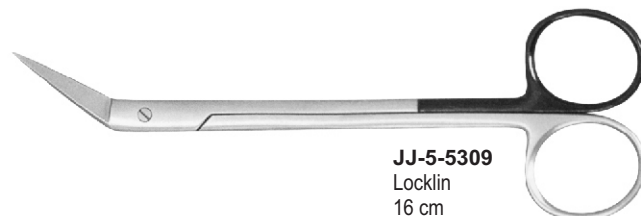
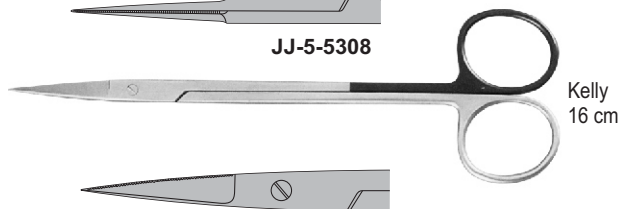
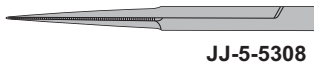
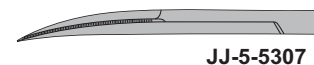

Super-Cut

- Cutting Blade horned to "razor" sharpness with opposing blade finished with fine serrations to avoid tissue slippage.
- Extremely smooth cutting with less trauma.
- Manufactured from high quality stainless steel to provide longer-lasting cutting edge.
- Single gold plated ring for easy identification.

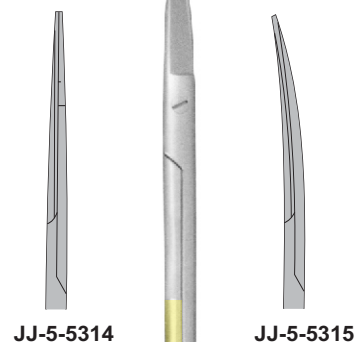
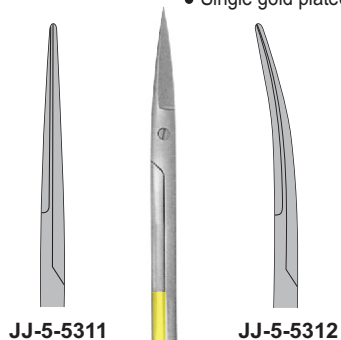

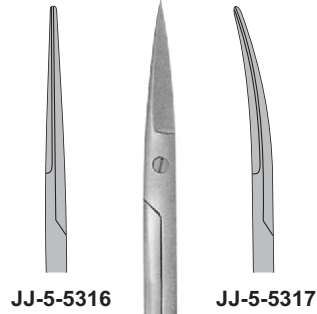

JJ-5-5316

JJ-5-5317



Iris
11.5 cm

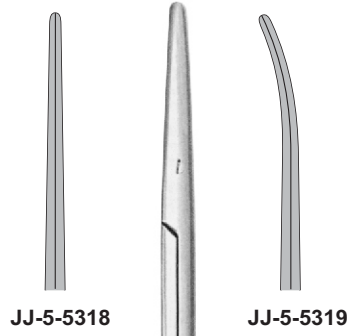

JJ-5-5318

JJ-5-5319



Metzenbaum
14.5 cm

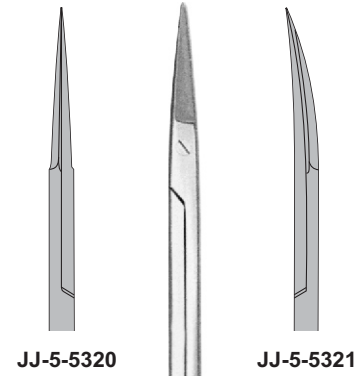

JJ-5-5320

JJ-5-5321



Kelly
16 cm

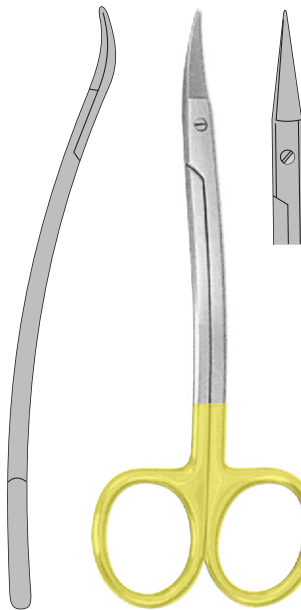

JJ-5-5322
La Grange
11.5 cm

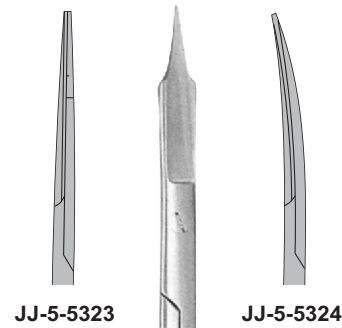

JJ-5-5323

JJ-5-5324



Goldman-Fox
13 cm

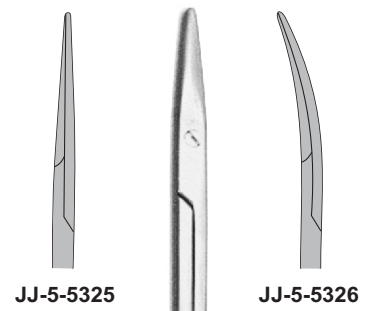

JJ-5-5325

JJ-5-5326



Strabismus
11.5 cm

Micro Scissors

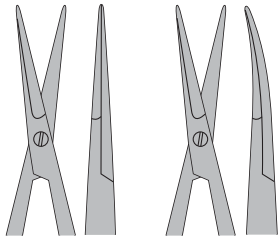
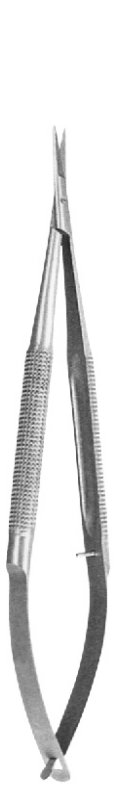

JJ-5-5327
15 cm

JJ-5-5328
15 cm

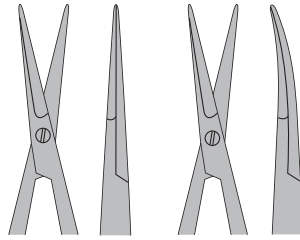
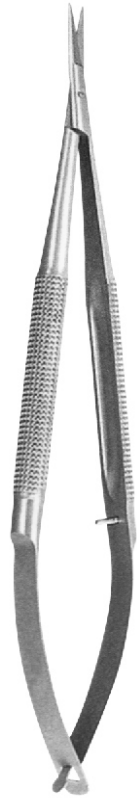

JJ-5-5329
18 cm

JJ-5-5330
18 cm

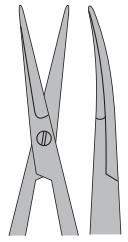

JJ-5-5331
18 cm

Micro Scissor
Stainless Steel

Micro Scissor
Stainless Steel

Micro Scissor
Stainless Steel
for ligature, one blade serrated

Micro Scissors with Titanium Stainless Steel Tips

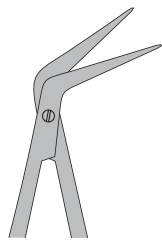

JJ-5-5332
18 cm

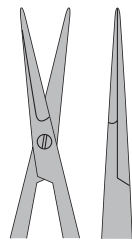

JJ-5-5333
18 cm

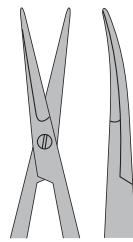

JJ-5-5334
18 cm

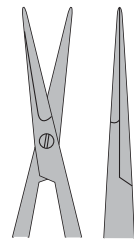

JJ-5-5335
15.5 cm

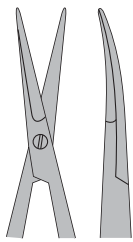

JJ-5-5336
15.5 cm

Page 110-114

- Dental Tweezers

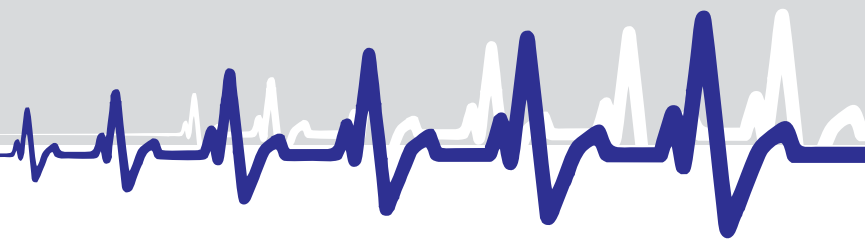

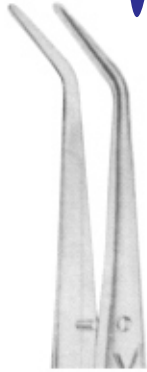

smooth



serrated



smooth



serrated

JJ-5-5337
College
15 cm

JJ-5-5338
College
15 cm

JJ-5-5339
College
15 cm

JJ-5-5340
College
15 cm



smooth



serrated



smooth



serrated

JJ-5-5341
College
15 cm

JJ-5-5342
College
15 cm

JJ-5-5343
College
15 cm

JJ-5-5344
College
15 cm

Dental Tweezers

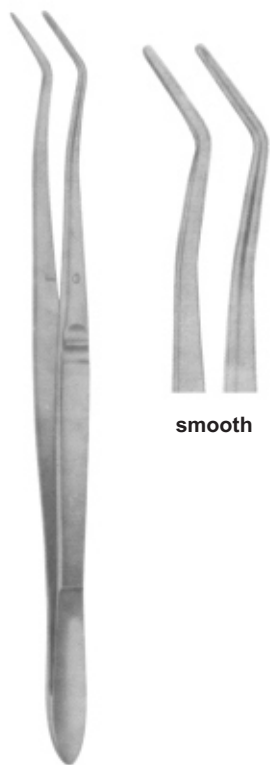

smooth

JJ-5-5345
Meriam
16 cm

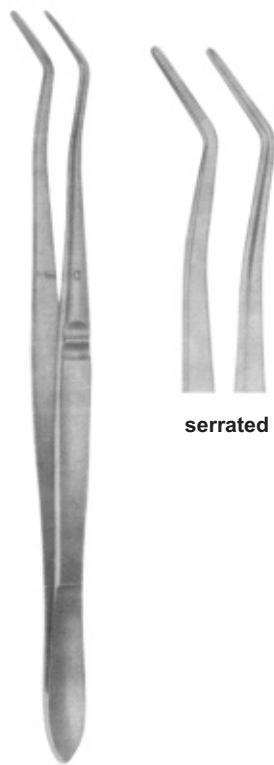

serrated

JJ-5-5346
Meriam
16 cm

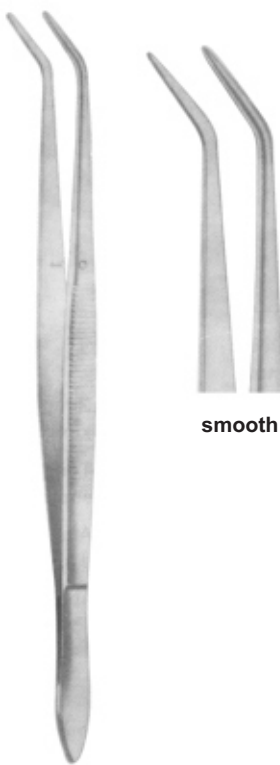

smooth

JJ-5-5347
Meriam
16 cm

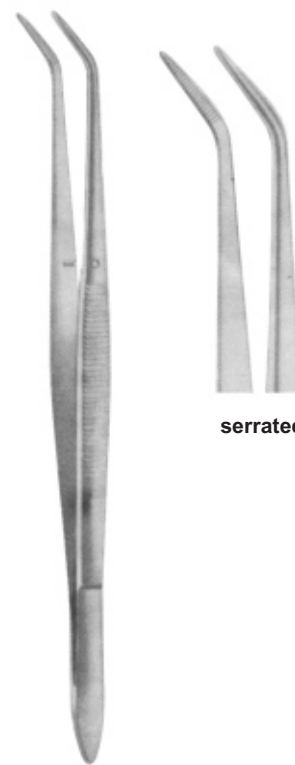

serrated

JJ-5-5348
Meriam
16 cm

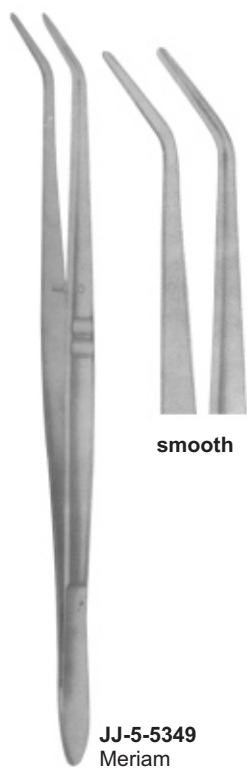

smooth

JJ-5-5349
Meriam
16 cm

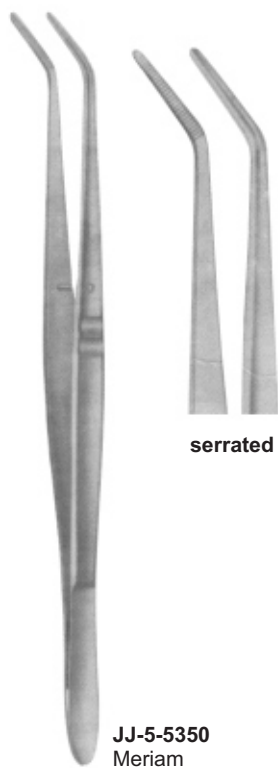

serrated

JJ-5-5350
Meriam
16 cm

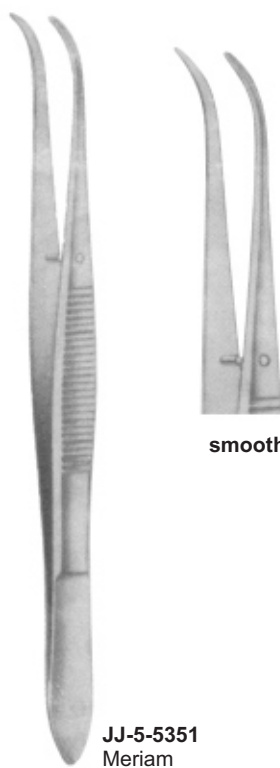

smooth

JJ-5-5351
Meriam
16 cm

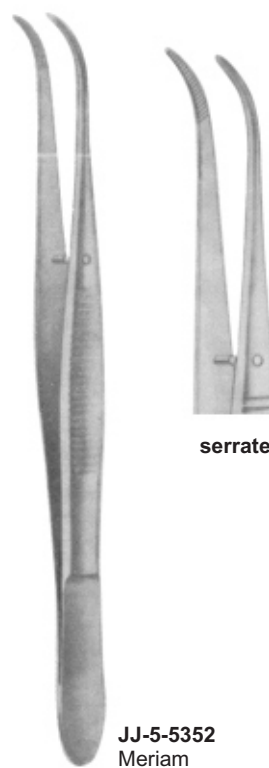

serrated

JJ-5-5352
Meriam
16 cm

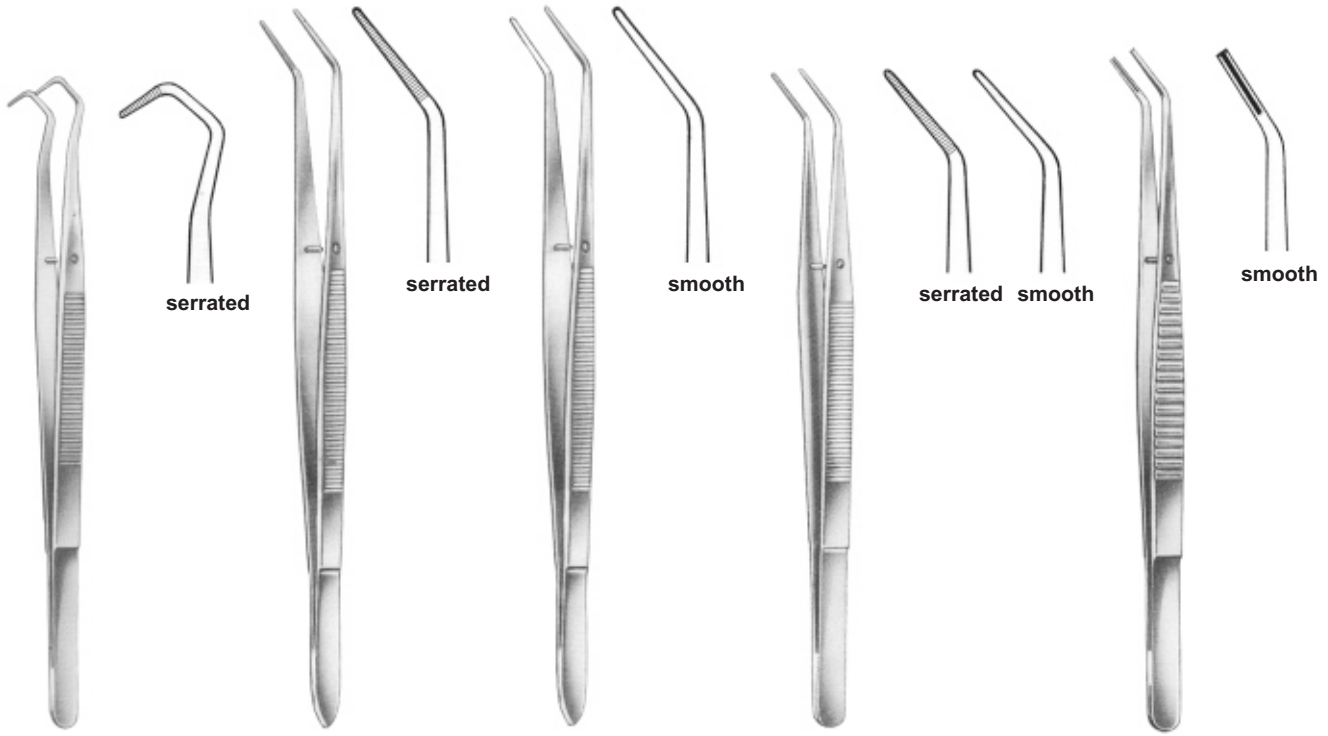

JJ-5-5353
College
14.5 cm, 5³/₄"

serrated

JJ-5-5354
Flagg
16 cm, 6¹/₄"

serrated

JJ-5-5355
Flagg
16 cm, 6¹/₄"

smooth

JJ-5-5356
Landgraf
15 cm, 6"

serrated smooth

JJ-5-5357
15,5 cm, 6¹/₈"

smooth

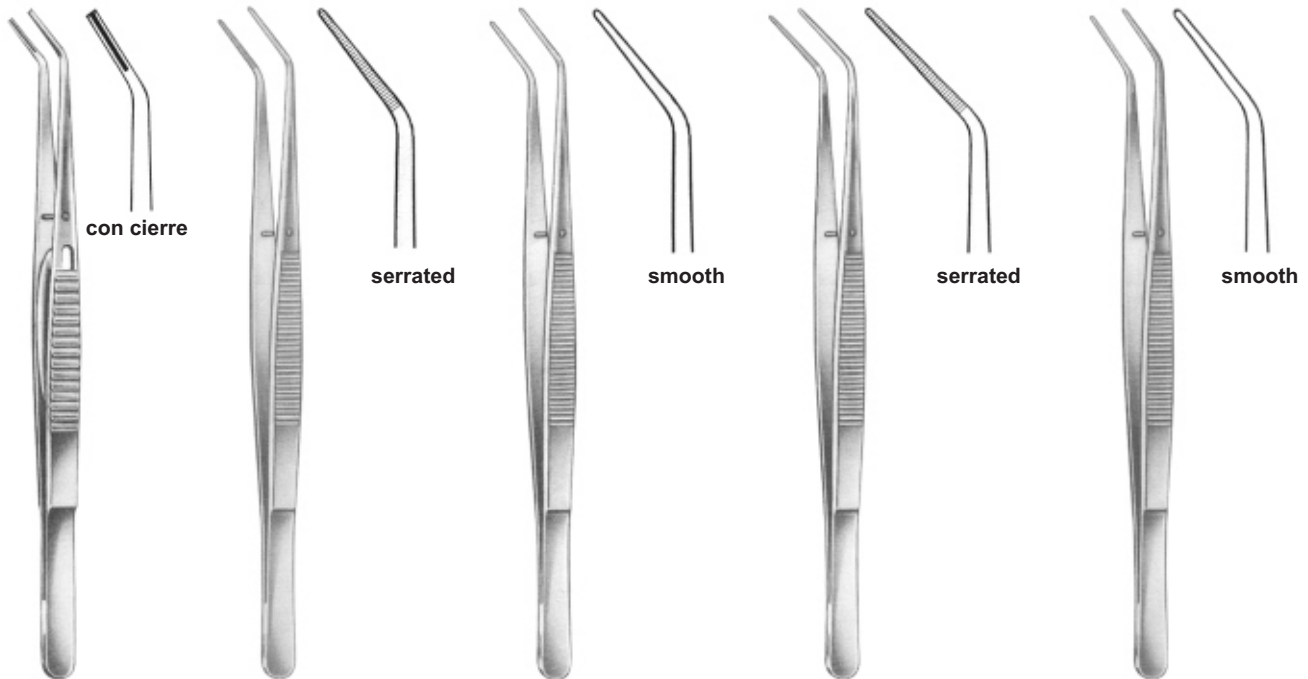

JJ-5-5358
15.5 cm, 6¹/₈"

con cierre

JJ-5-5359
London-College
15 cm, 6"

serrated

JJ-5-5360
London-College
15 cm, 6"

smooth

JJ-5-5361
London-College
15 cm, 6"

serrated

JJ-5-5362
London-College
15 cm, 6"

smooth

Dental Tweezers



JJ-5-5363
CK1
15 cm, 6"



JJ-5-5364
CK2
15 cm, 6"

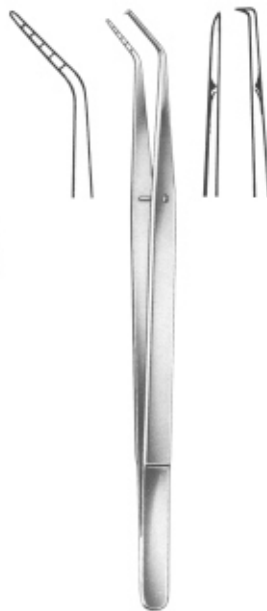

JJ-5-5365
GF2
16 cm, 6 1/4"



JJ-5-5366
Gf1
16 cm, 6 1/4"

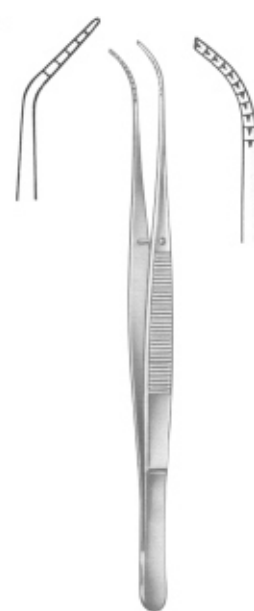

JJ-5-5367
Kopp
15.5 cm, 6 1/8"



JJ-5-5368
Kopp
15.5 cm, 6 1/8"



JJ-5-5369
15 cm, 6"



JJ-5-5370
16.5 cm, 6 1/2"



JJ-5-5371
15.5 cm, 6 1/8"



JJ-5-5372
15.5 cm, 6 1/8"



JJ-5-5373
London-College
15 cm, 6"

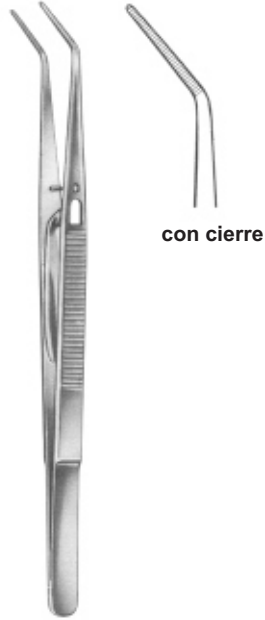

JJ-5-5374
London-College
15 cm, 6"

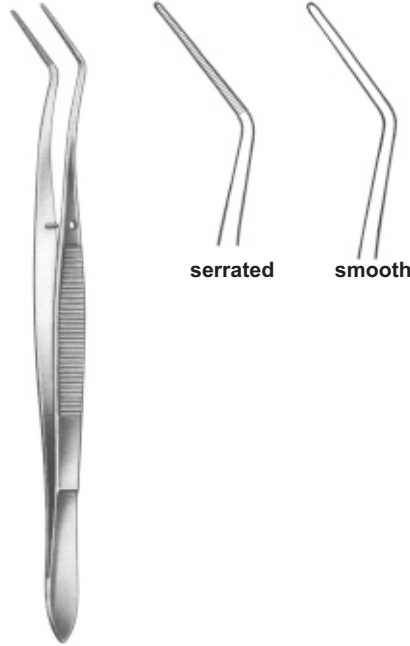

JJ-5-5375
Meriam
16 cm, 6 1/4"

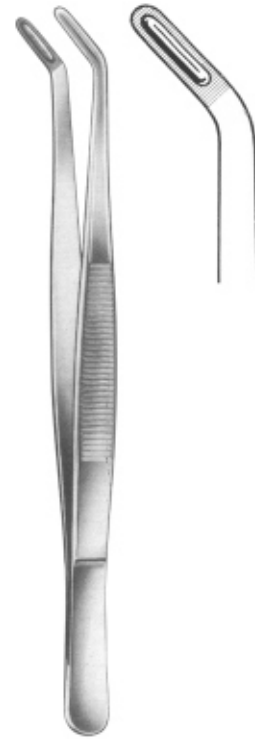

JJ-5-5376
Allen
18 cm, 7 1/8"

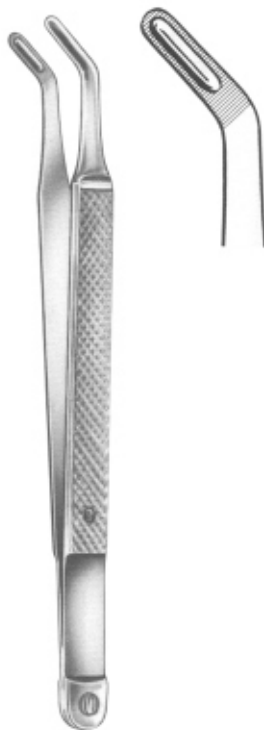

JJ-5-5377
Albrecht
16 cm, 6 1/4"



JJ-5-5378
Albrecht
16 cm, 6 1/4"



JJ-5-5379
16 cm, 6 1/4"



JJ-5-5380
16 cm, 6 1/4"



JJ-5-5381
16 cm, 6 1/4"

Page 115-117

- Rubber Dam Clamps

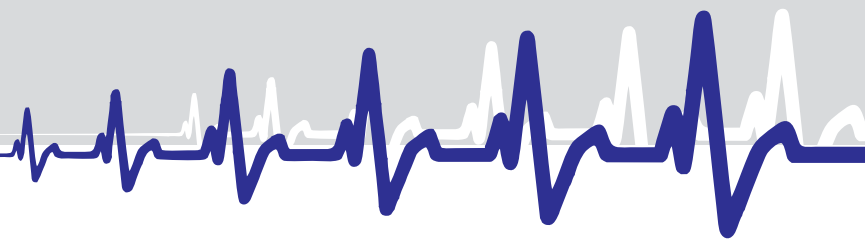

Rubber Dam Clamp Forceps

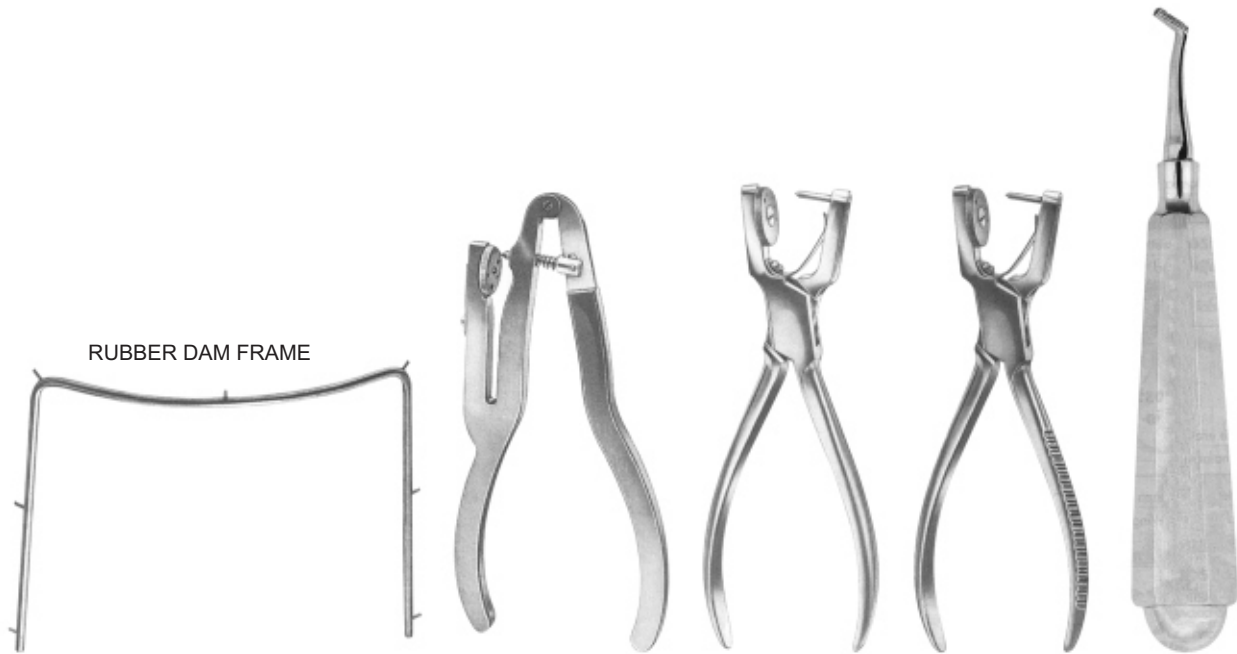

RUBBER DAM FRAME

JJ-5-5382
Young
105x95 Inox

JJ-5-5383
Ivory
160 mm

JJ-5-5384
Ainsworth
170 mm

JJ-5-5385
Ainsworth
170 mm

JJ-5-5386
Mershan
140 mm

CLAMPS (PLIERS)

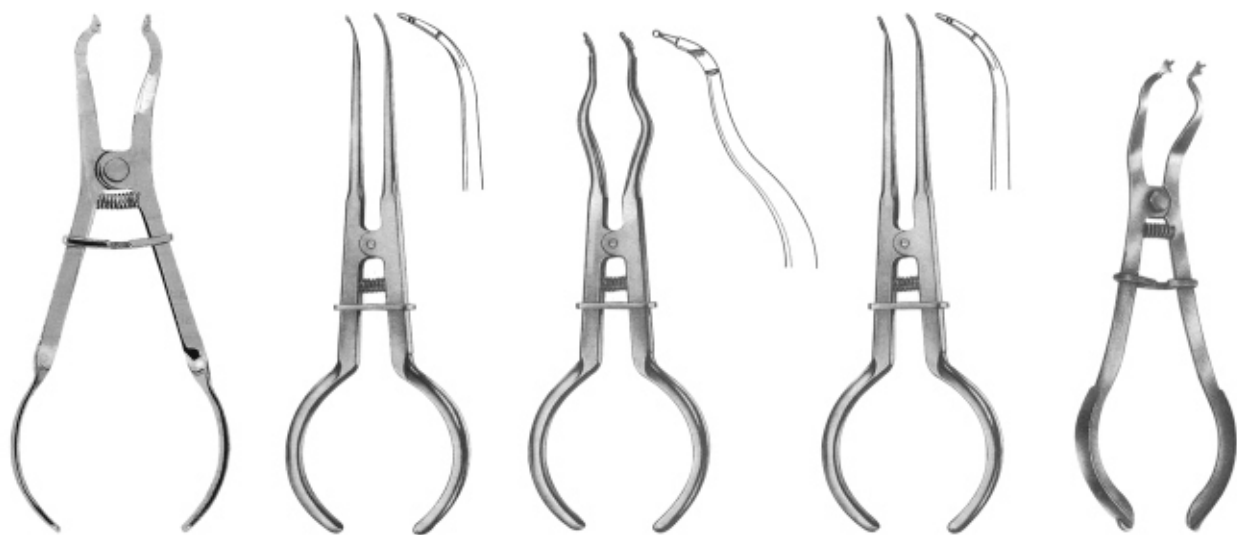

JJ-5-5387
Ivory light weight
170 mm

JJ-5-5388
Brewer
175 mm

JJ-5-5389
Brewer
175 mm

JJ-5-5390
White
175 mm

JJ-5-5391
Ivory
170 mm



JJ-5-5392
Winged
Labial Clamp



JJ-5-5393
Winged
Edged Labial Clamp



JJ-5-5394
Winged
Cervical Clamp



JJ-5-5395
Winged
Labial Clamp



JJ-5-5396
Winged



JJ-5-5397
Winged



JJ-5-5398
Wingless

For Small Teeth, Elongated or With Arrow Collars



JJ-5-5399
Winged



JJ-5-5400
Winged



JJ-5-5401
Wingless

For General Use With Adjustable Jaws According To Gingival Line Shapes



JJ-5-5402
Winged



JJ-5-5403
Edged, Winged



JJ-5-5404
Wingless

For Premolars, With Elongated Collar



JJ-5-5405
Winged



JJ-5-5406
Edged, Winged



JJ-5-5407
Wingless

For Premolars, With Elongated Collar



JJ-5-5408
Wingless



JJ-5-5409
Wingless

Rubber Dam Clamps



JJ-5-5410
Winged

JJ-5-5411
Wingless

JJ-5-5412
Winged

JJ-5-5413
Wingless

For Small Lower Molars

For Small Lower Molars With Round clamps



JJ-5-5414
Winged

JJ-5-5415
Wingless

JJ-5-5416
Winged

JJ-5-5417
Wingless

For Square Lower Molars

For Round Upper Molars



JJ-5-5418
Winged

JJ-5-5419
Wingless

JJ-5-5420
Winged

JJ-5-5421
Wingless

For Molar Roots

For Partially Broken Molars



JJ-5-5422
Winged

JJ-5-5423
Edged Winged

JJ-5-5424
Wingless

JJ-5-5425
Winged

JJ-5-5426
Wingless

For Round Molars, Partially Broken, Undersized or Inclined



JJ-5-5427
Wingless

JJ-5-5428
Wingless

JJ-5-5429
Winged

JJ-5-5430
Winged

Page 118–122

- Matrix Retainer
- Matrix Bands

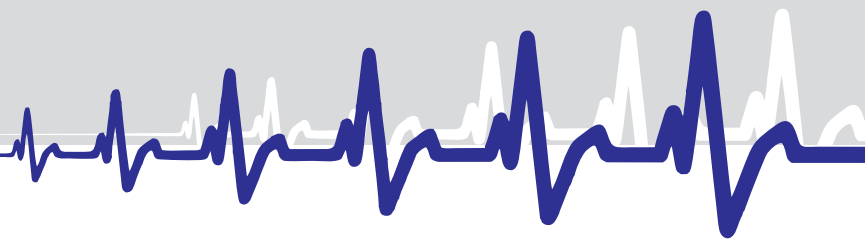

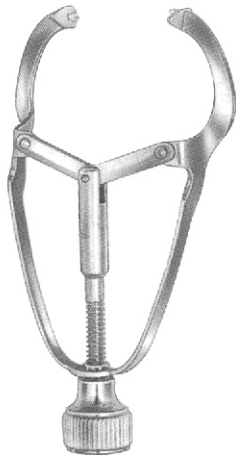

JJ-6-5101
Ivory
63mm

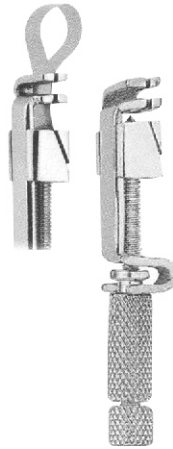

JJ-6-5102
Tofflemire-Universal



JJ-6-5103
Tofflemire-Junior



JJ-6-5104
Tofflemire-Senior



JJ-6-5105
Ivory 8
5 mm



JJ-6-5106
Ivory 8
6 mm



JJ-6-5107
Ivory 8
7 mm



JJ-6-5108
Ivory 8 N



JJ-6-5109
Didner 8 P



JJ-6-5111



JJ-6-5112



JJ-6-5113

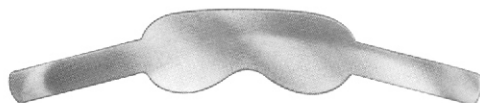

JJ-6-5114

1750-5 mm x 100 cm
1750-6 mm x 100 cm
1750-7 mm x 100 cm



JJ-6-5110

For Molars and Premolars



JJ-6-5115



JJ-6-5116



JJ-6-5117

Matrix Bands



7
JJ-6-5118
Molar
Fig 7

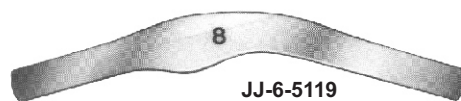

8
JJ-6-5119
Molar
Fig 8



9
JJ-6-5120
Molar
Fig 9

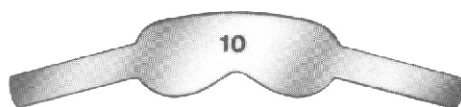

10
JJ-6-5121
Molar
Fig 10



1
JJ-6-5122
Tofflemire



2
JJ-6-5123
Tofflemire



3
JJ-6-5124
Tofflemire



11
JJ-6-5125
Bicuspid



12
JJ-6-5126
Bicuspid



13
JJ-6-5127
Bicuspid



1
JJ-6-5128
Bicuspid



2
JJ-6-5129
Bicuspid



3
JJ-6-5130
Bicuspid



JJ-6-5134



1
JJ-6-5131
Molar



2
JJ-6-5132
Molar



3
JJ-6-5133
Molars

Page 120–122

- Crown Removers
- Scissors
- Forceps
- Amalgum Guns
- Carries

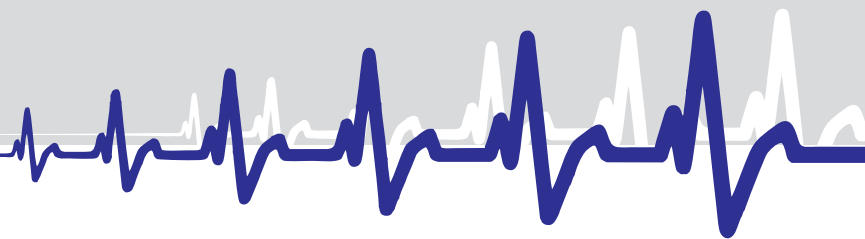

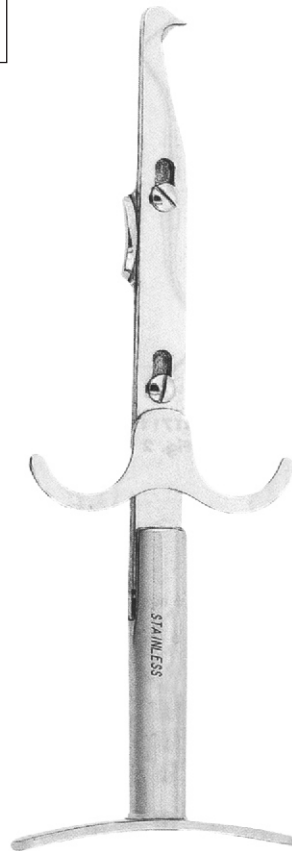
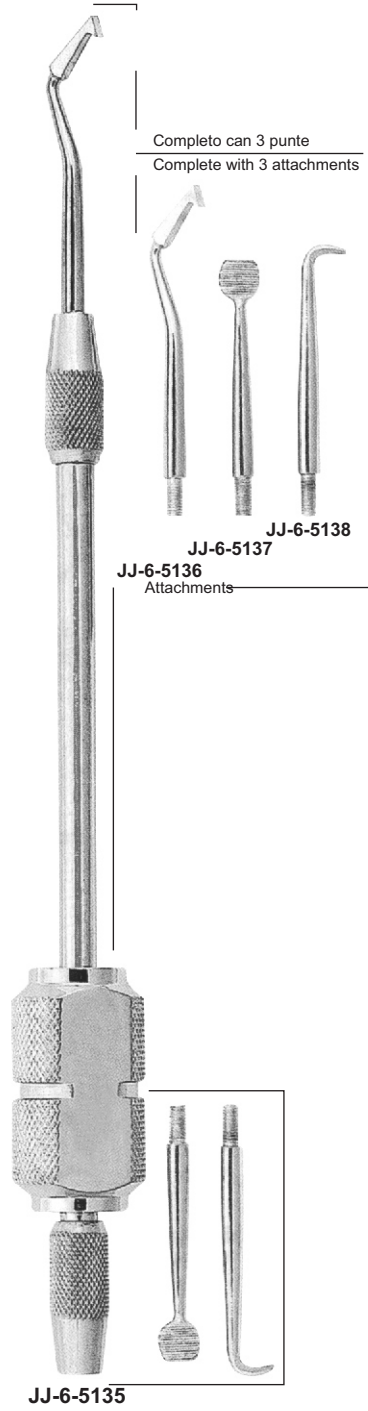

JJ-6-5139
Crown Spreader, Crown Remove.
Special instrument for crown spreading
after separating, simple and safe
operation.

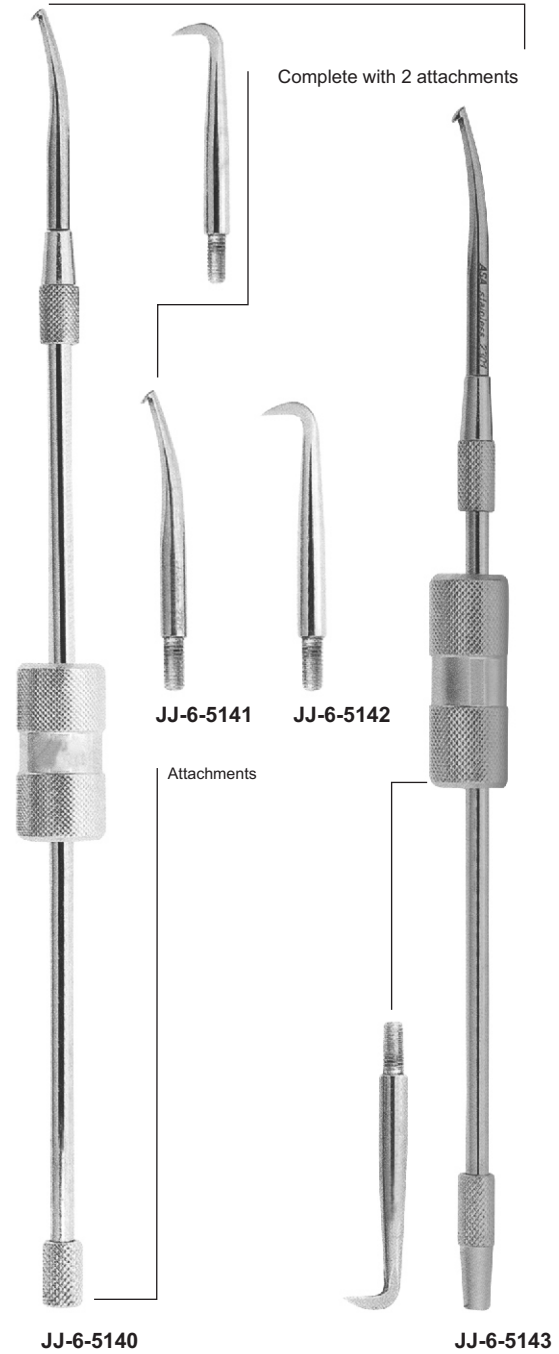

Dental Crown Removers, Scissors, Forceps, Amalgam Guns & Carriers



Universal "HM"
12 cm, 4 3/4"

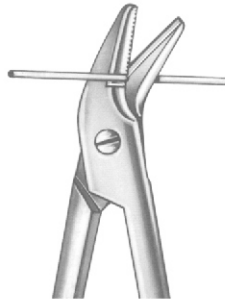

JJ-6-5144

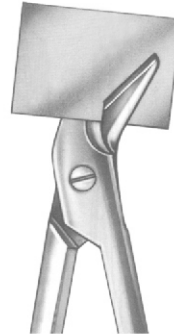

JJ-6-5145

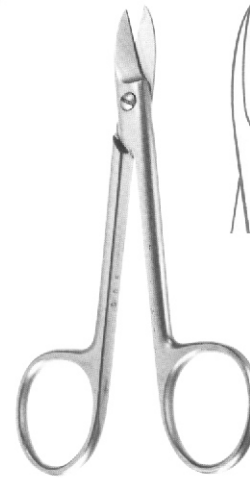

JJ-6-5146
Beebee
10,5 cm, 4 1/8"

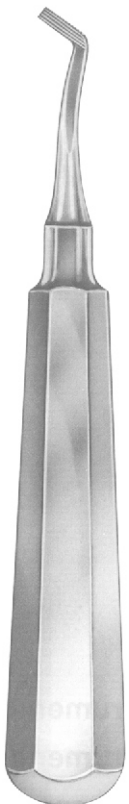

JJ-6-5147
Mershon



JJ-6-5148
Morell



JJ-6-5149
Morell



JJ-6-5150
Morell



JJ-6-5151
Morell



JJ-6-5152
Treyman

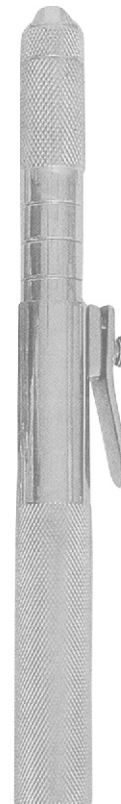

JJ-6-5153
Automatic Crown Remover
With 2 Points



JJ-6-5154



JJ-6-5155

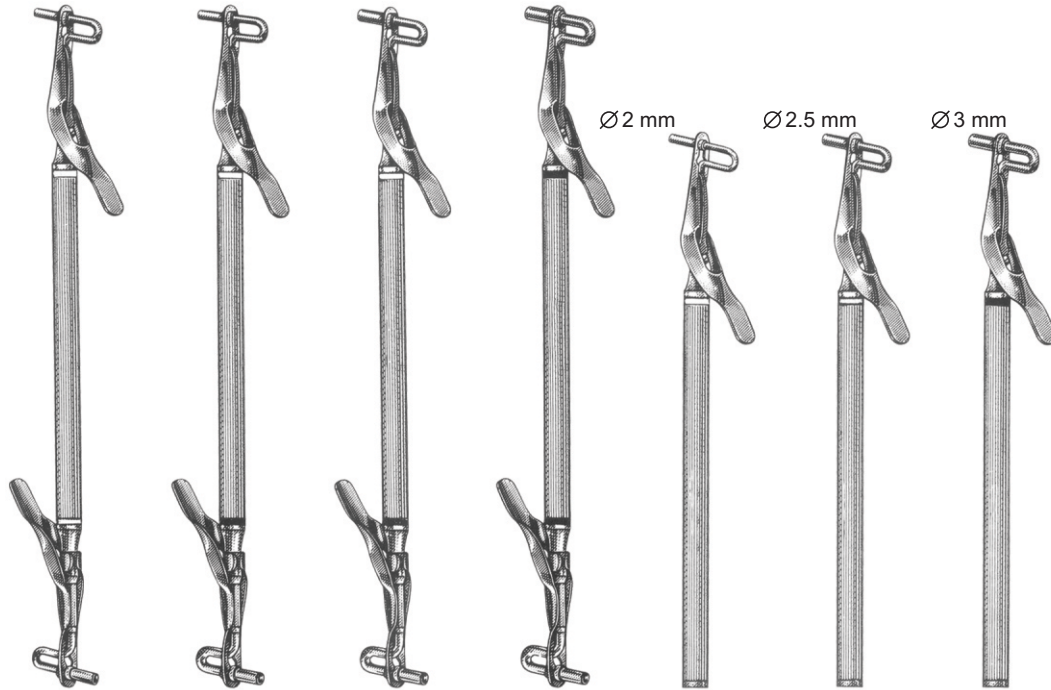

JJ-6-5156
Medium-Large
20 cm

JJ-6-5157
Medium-Jumbo
20 cm

JJ-6-5158
Large-Jumbo
20 cm

JJ-6-5159
Jumbo-Jumbo
20 cm

JJ-6-5160
Medium
15.5 cm

JJ-6-5161
Large
15.5 cm

JJ-6-5162
Jumbo
15.5 cm

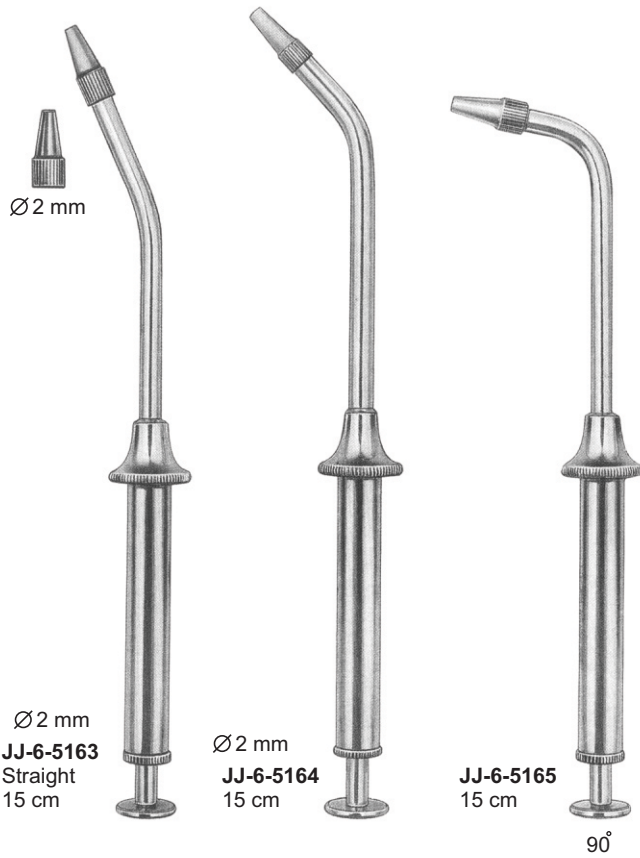

Ø 2 mm
JJ-6-5163
Straight
15 cm

Ø 2 mm
JJ-6-5164
15 cm

JJ-6-5165
15 cm

90°

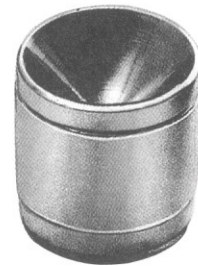

JJ-6-5166
Amalgam Well
Non Skid Base
Ø 3.5 mm

Page
123

- Copper Ring Removing Plierspaper Articulator Forceps

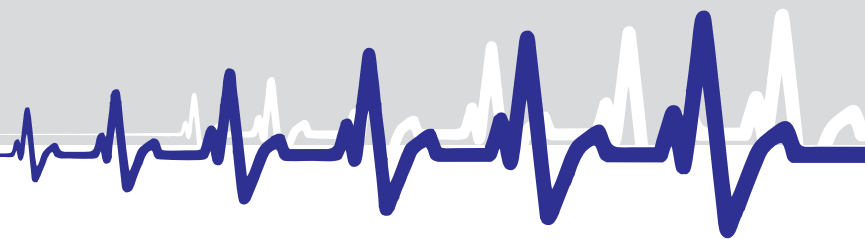

Copper Ring Removing Pliers, Paper Articulator Forceps

Copper ring removing pliers



JJ-6-5167
Bohm
11,5 cm



JJ-6-5168
Bohm
14,5 cm



JJ-6-5169
Furrer
16 cm



JJ-6-5170
Furrer
16 cm

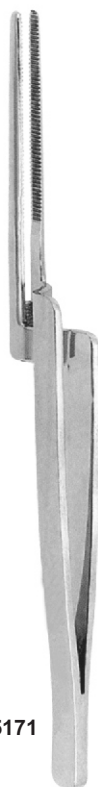

JJ-6-5171
Miller
15 cm



JJ-6-5172
Miller
15 cm



JJ-6-5173
Kelly
14 cm



JJ-6-5174
Halstead-Mosquito
12 cm



JJ-6-5175
Micro-Mosquito
10 cm

Page 124-127

- Rongeurs

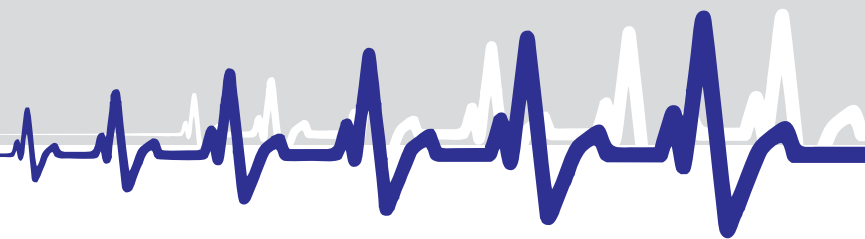

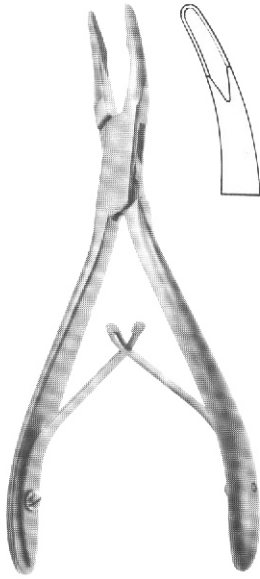

JJ-6-5176
Friedmann
14 cm, 5 1/2"

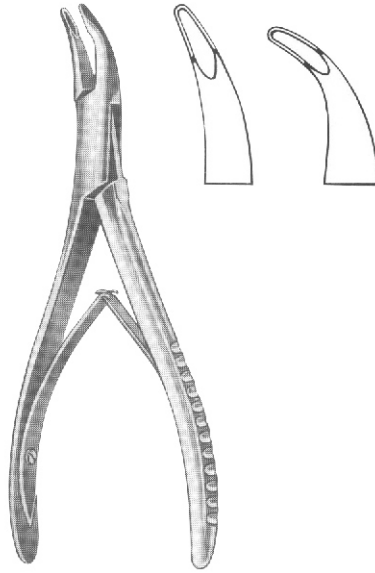

JJ-6-5177
14 cm, 5 1/2"

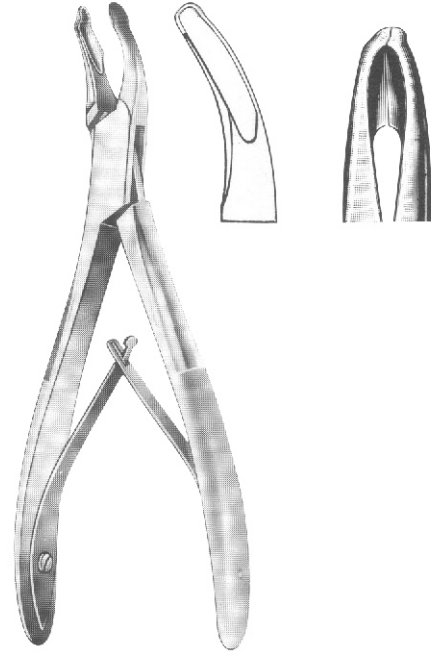

JJ-6-5178
Mead
14 cm, 5 1/2"

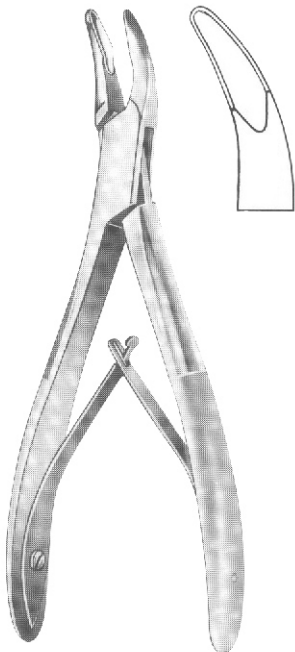

JJ-6-5179
Mead
14 cm, 5 1/2"

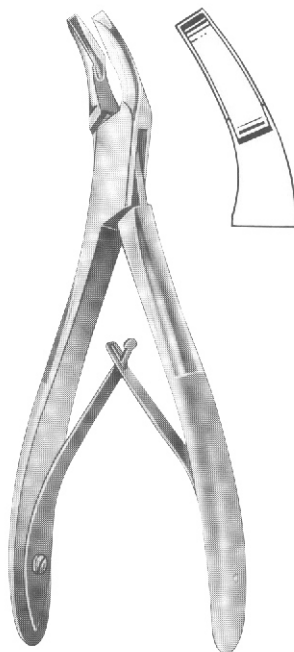

JJ-6-5180
Mead
17 cm, 6 3/4"

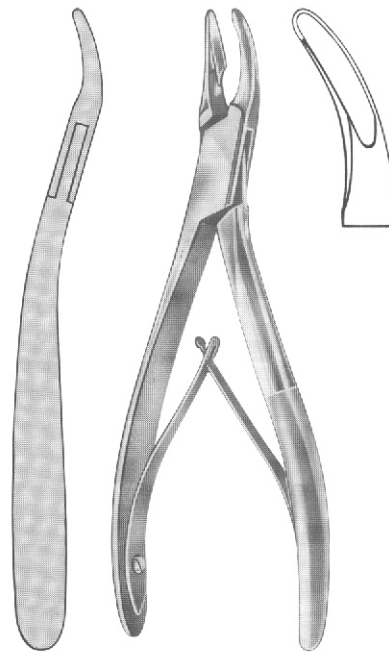

JJ-6-5181
Schell
17 cm, 6 3/4"

Bone Rongeurs



JJ-6-5182
Luer
15 cm



JJ-6-5183
Friedman
14 cm



JJ-6-5184
Mini Friedman
12 cm



JJ-6-5185
Goldman-Fax
10 cm



JJ-6-5186
Blumenthal
15 cm



JJ-6-5187
Blumenthal 45
14,5 cm



JJ-6-5188
Blumenthal 90
14 cm

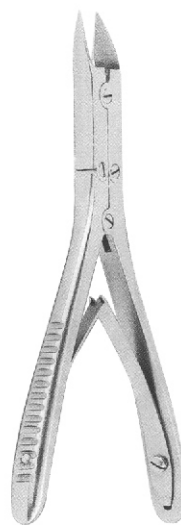

JJ-6-5189
Bohler
15 cm



JJ-6-5190
Kerrison
15 cm

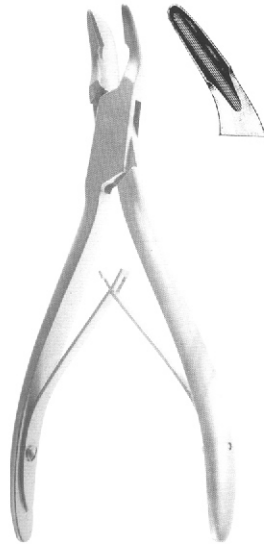

JJ-6-5191
Blumenthal
16 cm, 6 1/4"

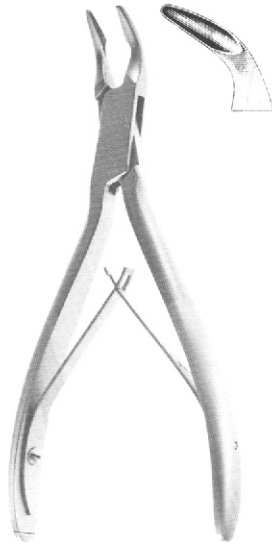

JJ-6-5192
Blumenthal
16 cm, 6 1/4"

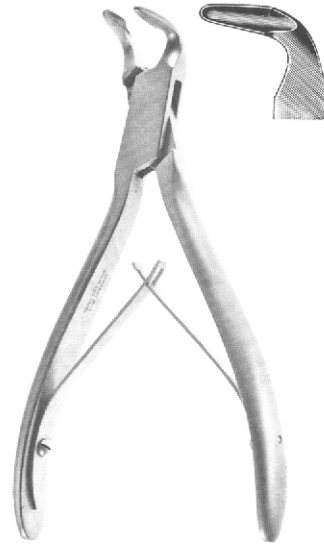

JJ-6-5193
Blumenthal
16 cm, 6 1/4"

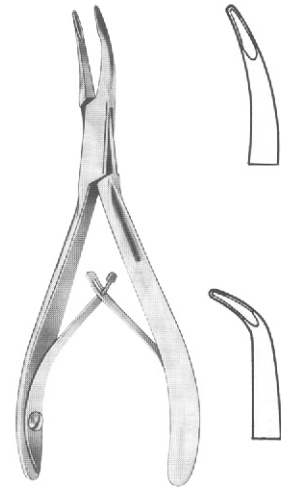

JJ-6-5194
Kleinert-Kutz
14 cm, 5 1/2"

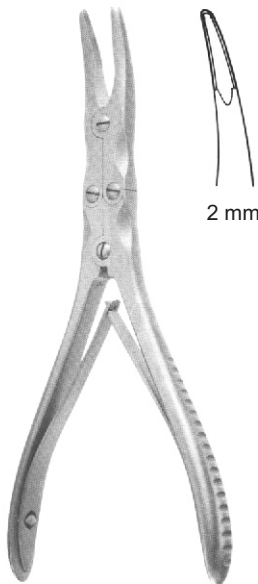

JJ-6-5195
Ruskin-Mini
15 cm

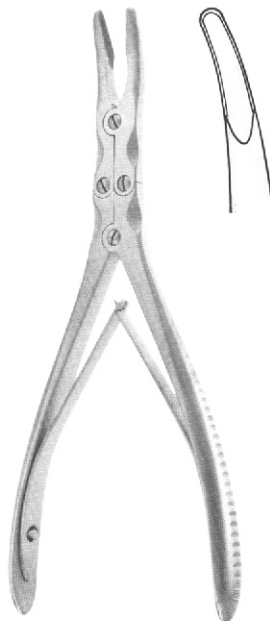

JJ-6-5196
Beyer
18 cm, 7 1/8"

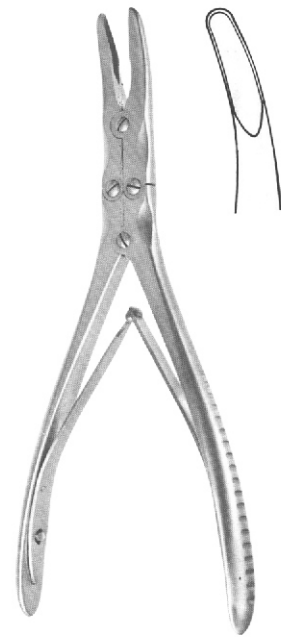

JJ-6-5197
Zaufal-Jansen
18 cm, 7 1/8"

Rongeurs

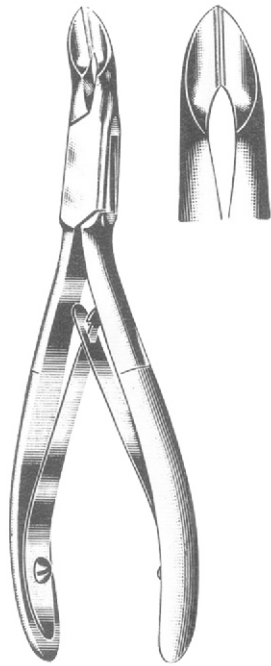

JJ-6-5198
Niro
No. 5 S, 14 cm, 5 1/2"

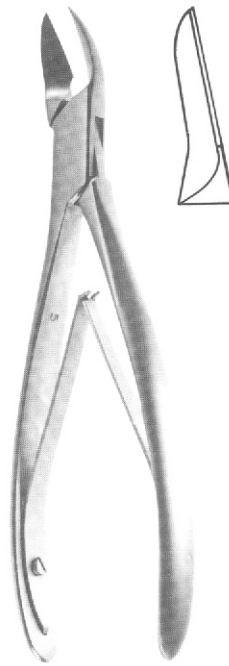

JJ-6-5199
Cleveland
No. 5 S, 17 cm, 6 3/4"

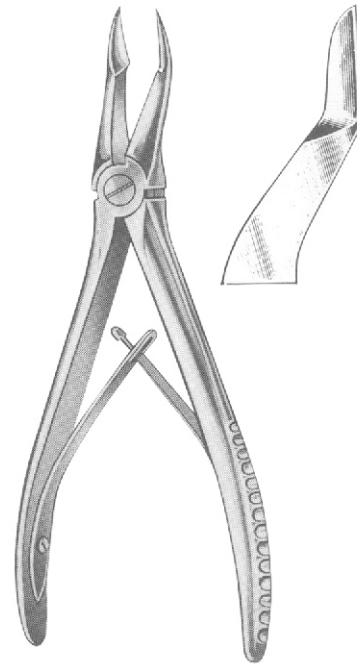

JJ-6-5200
No. 18, 15 cm, 6"

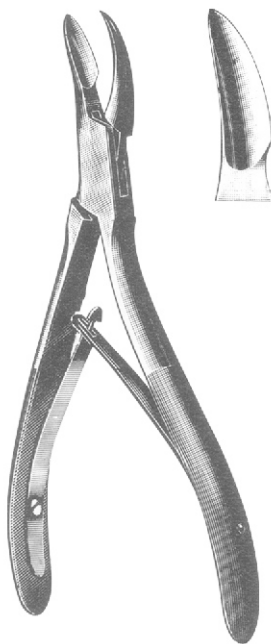

JJ-6-5201
Cleveland
16 cm, 6 1/4"

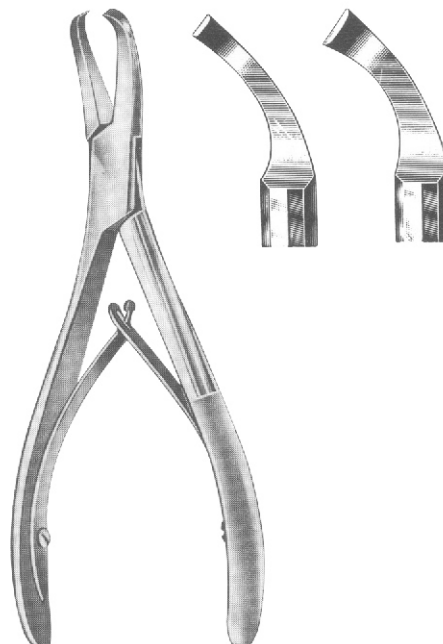

JJ-6-5202
Gardner
16 cm, 6 1/4"



JJ-6-5203
Liston-mini
15 cm, 6"

Page 128–129

- Bone Elevators, Bone Files and Chisels

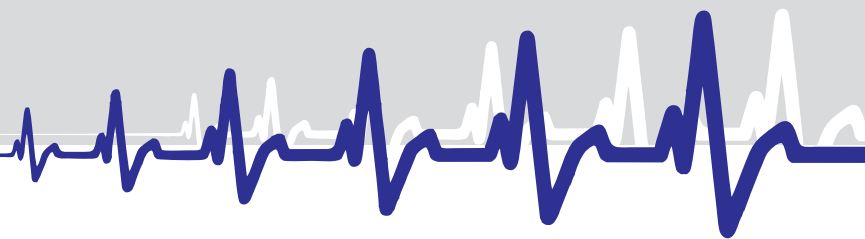

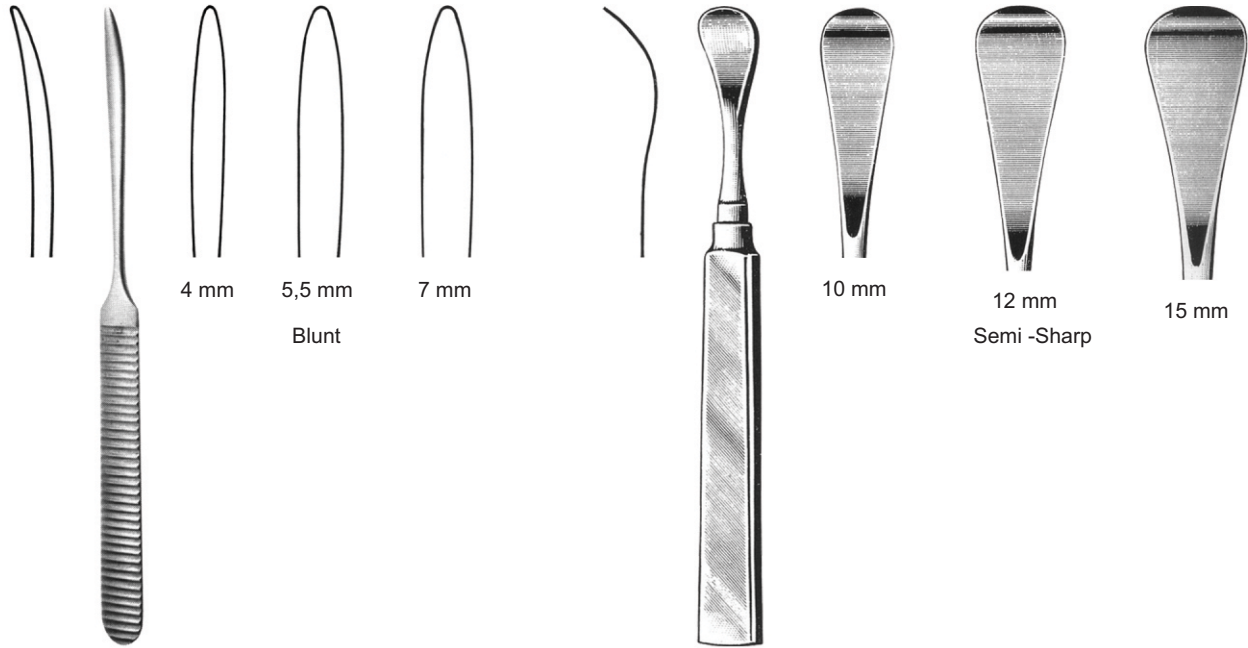

JJ-6-5204
Williger
16 cm, 6 1/4"

JJ-6-5205
HeAlhan
17 cm, 6 3/4"

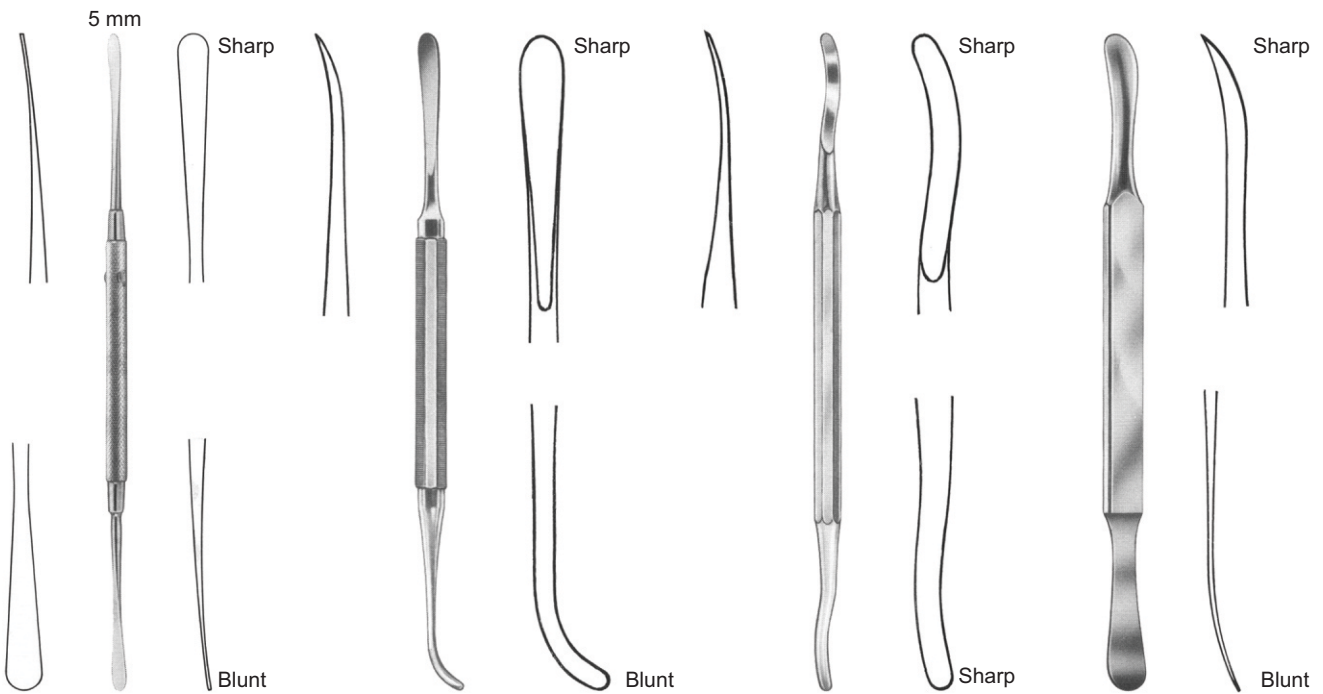

JJ-6-5206
Freer
19 cm, 7 1/2"

JJ-6-5207
Bennet
17 cm, 6 3/4"

JJ-6-5208
Seldin
19 cm, 7 1/2"

JJ-6-5209
Seldin
19,5 cm, 7 3/4"

Bone Files and Chisels



Buckley
15 cm, 6"



JJ-6-5210
No. 1
3mm



JJ-6-5211
No. 2
4mm



JJ-6-5212
No. 3
5mm

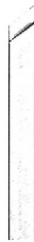

JJ-6-5213
No. 4
4mm



JJ-6-5214
No. 5
4mm



JJ-6-5215
Killian
16 cm, 6 1/4" 5 mm

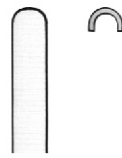

JJ-6-5216
Killian-Claus
16 cm, 6 1/4" 5 mm

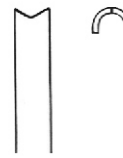

Obwegeser



JJ-6-5217
2,5 mm



JJ-6-5218
4 mm



JJ-6-5219
Miller
No.10C



JJ-6-5220
Miller
No.11C



JJ-6-5221
Miller
No.12C



JJ-6-5222
Miller
No.13C



Page 130–151

- Pliers For Orthodontics
- Mouth Gags
- Tongue Depressors
- Lip and Cheek Retractors
- Implantology Instruments

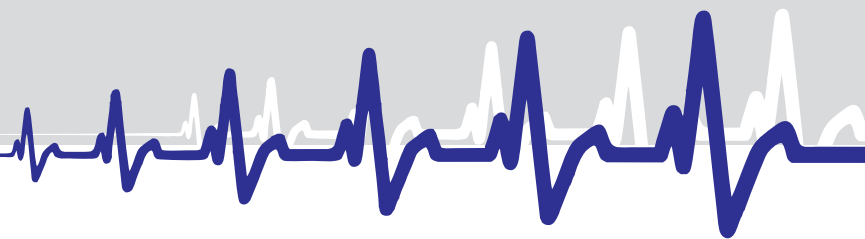

Pinze per formare loops
Loops forming pliers



JJ-7-5101
Adams

Adams pliers for bending
wires up to 0,7mm. (.28").

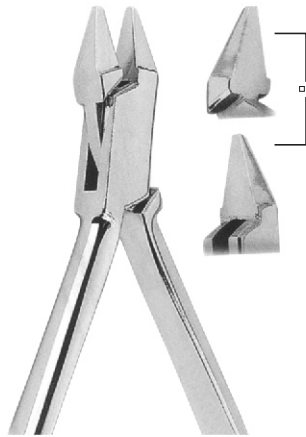

JJ-7-5102
Adams

Adams pliers for bending
wires up to 0,7mm. (.28").

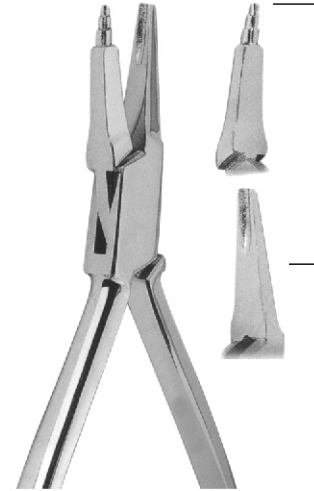

JJ-7-5103
Adams

Tweed loop forming pliers.
For forming loop in wires up
to 0,56 mm. (.22").



JJ-7-5104
Adams

Aderer three jaws bending
pliers. For wires up
to 0,7 mm. (.28").



JJ-7-5105
Adams

Aderer three jaws bending
pliers. For wires upto 0,7 mm.
(.28").

Ligature Cutter Pliers



JJ-7-5106

Micro-miniature light wire cutter. It cuts soft ligature wires. For use in caso of limited access. Caution: maximum cutting capacity: soft ligature wire up to 0,30 mm. (.012").



JJ-7-5107

Wire cutter. For ligature wires and pins. It is strong enough to bend archwire ends after distal cutting. Maximum cutting capacity up to 0,56 x 0,7 mm. (.022" x .028").

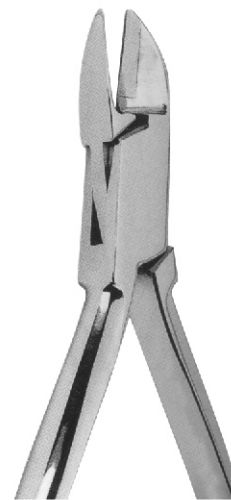

JJ-7-5108

Wire cutter. For ligature wires and pins. It is strong enough to bend archwire ends after distal cutting. Maximum cutting capacity: up to 0,9 mm. (.036").

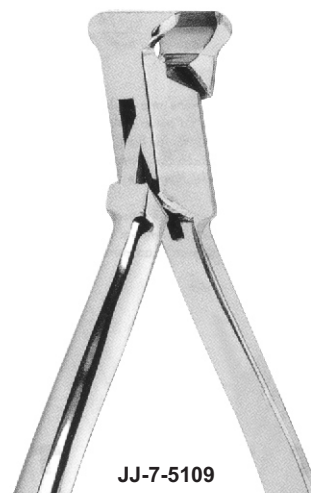

JJ-7-5109

Wire cutter. For ligature wires and pins. It is strong enough to bend archwire ends after distal cutting. Maximum cutting capacity: up to 1,5 mm. (.044").

Pinze per formare laboratorio
Laboratory pliers



JJ-7-5110

Flat nose pliers with smooth beaks for bending wires up to 0,7 mm. (.028").

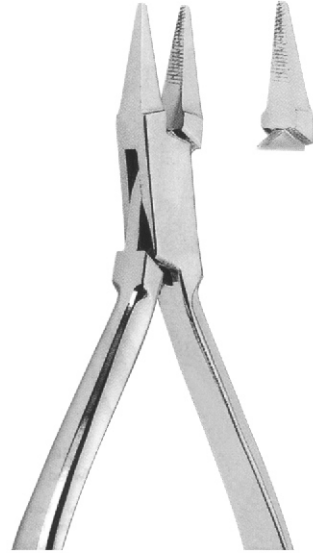

JJ-7-5111

Bending wires up to 0,7 mm. (.028").



JJ-7-5112

Bending wires up to 0,7 mm. (.028").



JJ-7-5113

Bending wires up to 0,7 mm. (.028").

Pliers for Othodontics



JJ-7-5114
Alnce

Alnce loop closing pliers, for bending of stop loops and special for Adams' clasps. Wires up to 0,7 mm. (.028").



JJ-7-5115
Alnce

Universal pliers for bending wires up to 0,9 mm. (.035") or cutting up to 0,7 mm. (.028").

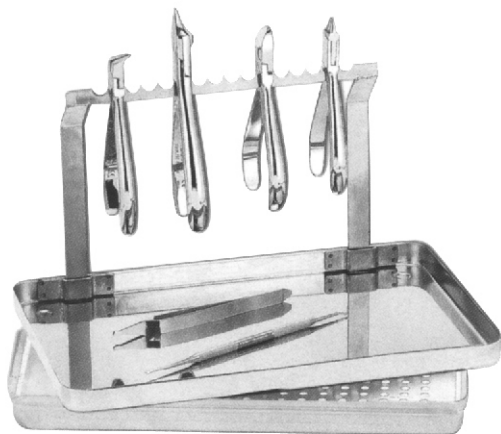

JJ-7-5116

Stainless steel pliers tray standard dimensions



JJ-7-5117
Universal

Universal pin roughening, cutting and bending pliers. For wires up to 0,9 mm. (.035"). Will cut wires up to 0,7 mm. (.028").

Utility and specialty pliers



JJ-7-5118
Reynolds

Reynolds contouring pliers.

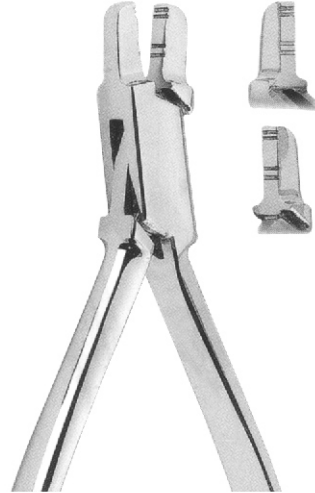

JJ-7-5119
Reynolds

Lingual arch pliers used to form double and triple back bends in 0,7 mm (.028") or 0,9 mm (.035") wire for insertion in lingual sheaths.



JJ-7-5120
Weingart

Weingart pliers with serrated points.

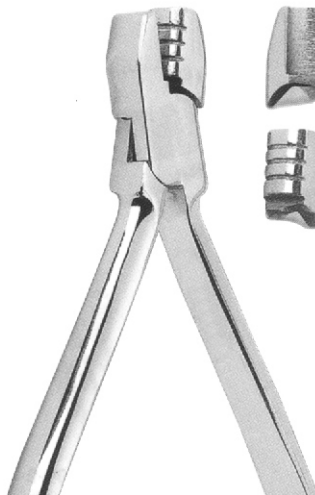

JJ-7-5121
De La Rosa

De La Rosa arch forming pliers. Designed to form and contour arch wires on round or rectangular wire. The beak has grooves of 0,4 mm (.016"), 0,46 mm (.018") and 0,56 mm (.022").



JJ-7-5122
De La Rosa

Arch forming pliers with a non grooved contouring surface the forming of precise arches.

Pliers for Othodontics

Loop formare pliers



JJ-7-5123
Waldsachs

Waldsachs universal pliers for bending wires up to 1,0 mm. (.039") or cutting up to 0,7 mm. (.028").



JJ-7-5124

Round and Concave pliers for loop forming and bending of thin round and square wires up to 0,5 mm. (.020").

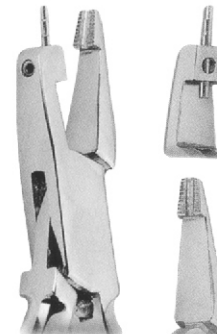

JJ-7-5125
Tweed

Tweed loop Forming Pliers. For round or rectangular wires up to 0,56 x 0,7 mm. (.022" x .028"). Replaceable cylindrical beak with three sizes: 1,15 mm. (.045), 1,50 mm. (.059"), 1,90 mm. (.075"). Concave beak with slight parallel serrations, to keep the wire in proper position.

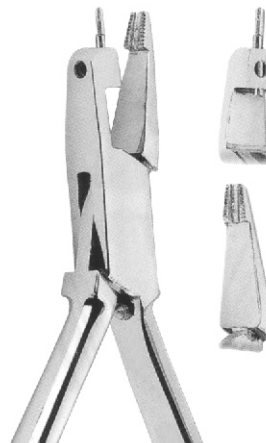

JJ-7-5126
Tweed

Tweed Loop Forming Pliers. For making perfect Omega Loops with round or rectangular wires up to 0,56 x 0,7 mm. (.022" x .028"). The concave beak is exactly the same as pliers 5809-1

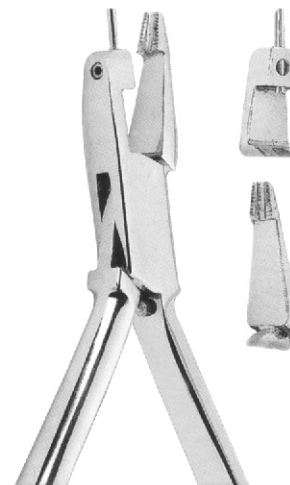

JJ-7-5127
Tweed

Single diameter loop forming pliers. Wire up to 0,56 x 0,7 mm. (.022" x 0.28"). Replaceable concave beak has only one diameter section of 1,50 mm. (.059").

Distal end cutters



JJ-7-5128

Distal end cutter -safety hold- a precision cutter designed for distal arch cutting in the patient's mouth. It cuts hard wires end holds the loose distal end preventing any damaging of oral tissue. Maximum cutting capacity rectangular wires up to 0,56 x 0,7 mm. (.022" x .020").

D.B. brachet remover pliers



JJ-7-5129

Micro- distal end cutter - safety hold-. Similar to 3227



JJ-7-5130

Direct bonding bracket remover (wide). The removal grip firmly for easy incisal-gingival (vertical) use or, if needed, for mesial-distal (horizontal) use with the same ease.

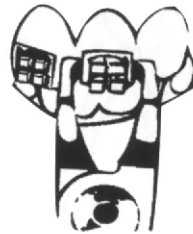

JJ-7-5131

Direct bond attachment remover (angled). For removing all bonded attachments. May be used mesial-distal-horizontal) or incisal-gingival (vertical) in anterior areas. Angled perfectly for easy access to difficult posterior areas.

Pliers for Othodontics

Bird beak pliers



JJ-7-5132

Wire bending pliers. For wires up to 0,9 mm. (.036").

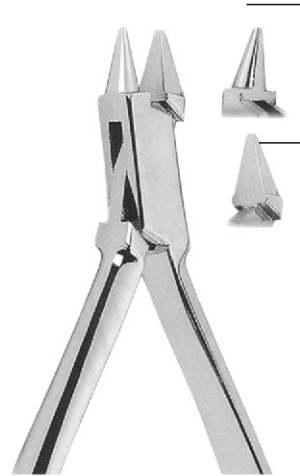

JJ-7-5133

Bird Beak Angle pliers for bending round, square or rectangular wire up to 0,7 mm. (.028").



JJ-7-5134

Double rounded jaw wire bending pliers. For wires up to 0,7 mm. (.028").



JJ-7-5135

Bird beak pliers for bending round, square or rectangular wire up to 0,7 mm. (.028"). With cutter.

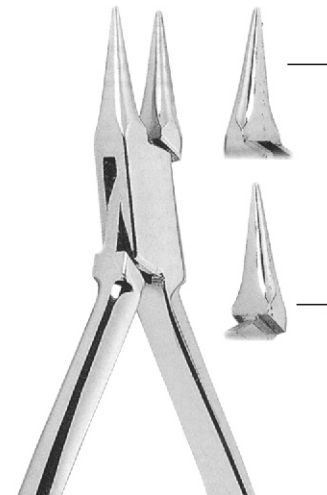

JJ-7-5136

Double rounded jaw wire bending pliers. For wires up to 0,7 mm. (.028").



JJ-7-5137
USA Model
125 mm



JJ-7-5138
Waldron
125 mm



JJ-7-5139
How
140 mm



JJ-7-5140
How
145 mm

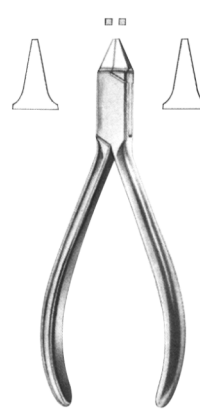

JJ-7-5141
Adams
125 mm



JJ-7-5142
Angle
125 mm



JJ-7-5143
young
130 mm



JJ-7-5144
Alnce
130 mm



JJ-7-5145
Weingart
140 mm



JJ-7-5146
Johnson
130 mm



JJ-7-5147
Mc Kellops
155 mm



JJ-7-5148
Universal
150 mm

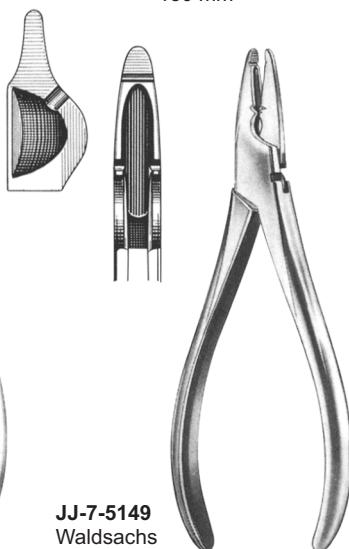

JJ-7-5149
Waldsachs
155 mm

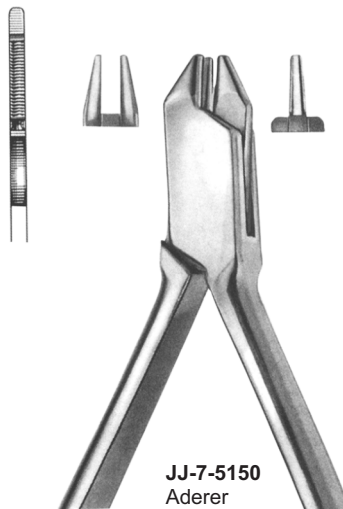

JJ-7-5150
Aderer
125 mm



JJ-7-5151
Alnce
130 mm

Pliers for Othodontics and Prosthetics

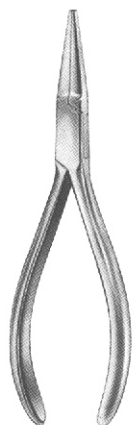

JJ-7-5152
Langenbeck
140 mm



JJ-7-5153
Langenbeck
130 mm



JJ-7-5154
Langenbeck
130 mm



JJ-7-5155
Peeso
125 mm



JJ-7-5156
Goslee
125 mm

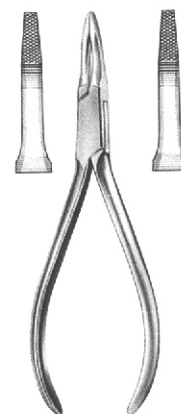

JJ-7-5157
Fischer
140 mm

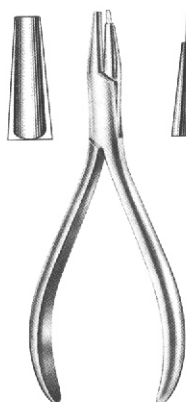

JJ-7-5158
Andresen
130 mm

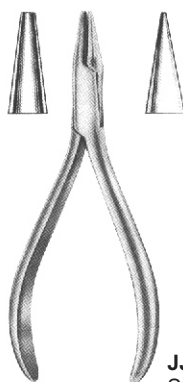

JJ-7-5159
Schwarz
130 mm

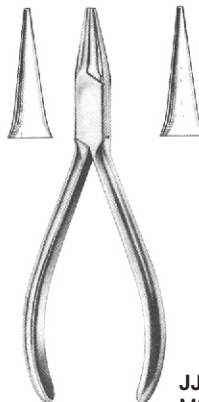

JJ-7-5160
MSY
130 mm

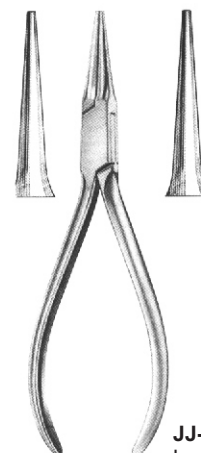

JJ-7-5161
Langenbeck
125 mm



JJ-7-5162

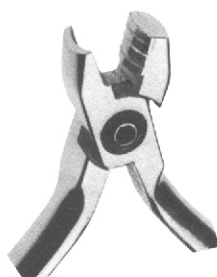

JJ-7-5163

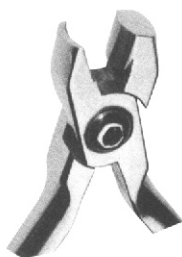

JJ-7-5164



JJ-7-5165

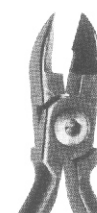

JJ-7-5166



JJ-7-5167



JJ-7-5168



JJ-7-5169

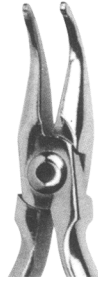

JJ-7-5170

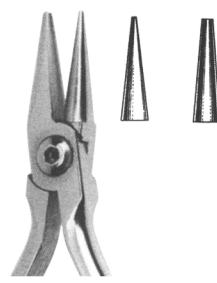

JJ-7-5171

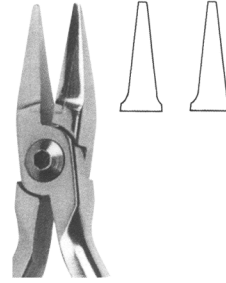

JJ-7-5172

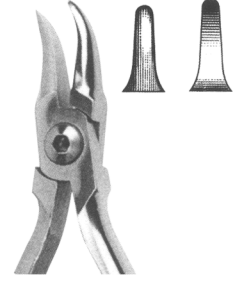

JJ-7-5173

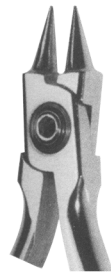

JJ-7-5174

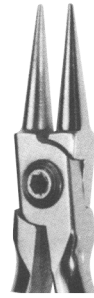

JJ-7-5175

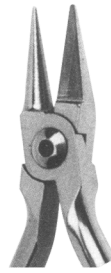

JJ-7-5176

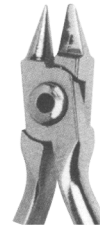

JJ-7-5177



JJ-7-5178

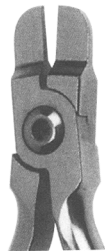

JJ-7-5179

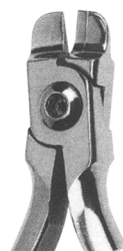

JJ-7-5180



JJ-7-5181

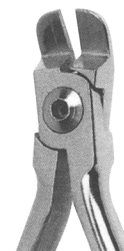

JJ-7-5182

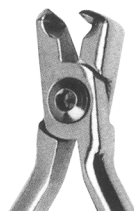

JJ-7-5183

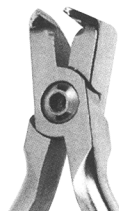

JJ-7-5184

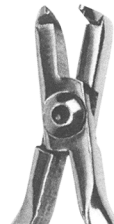

JJ-7-5185

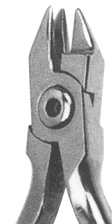

JJ-7-5186

Mouth Gags



Molt
JJ-7-5187 10 cm
JJ-7-5188 11 cm
JJ-7-5189 14 cm



JJ-7-5190 16 cm
JJ-7-5191 19 cm
 Roser-König



JJ-7-5192
 Denhardt
 13 cm



JJ-7-5193
 Fergusson - Ackland
 14.5 cm



JJ-7-5194
 Heister
 Maunder Wood
 9.5 cm



JJ-7-5195
 Obwegeser 11 cm
 Spreading 47 mm



JJ-7-5196
 Heister
 13 cm



JJ-7-5197 Small
JJ-7-5198 Medium
JJ-7-5199 Large
 Cheek Retractor

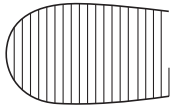
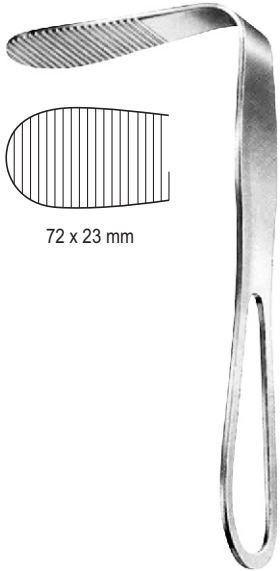

72 x 23 mm

JJ-7-5200
Hartmann
15 cm



JJ-7-5201
Doyen Tongue Spatula
13.5 cm



JJ-7-5202
14.5 cm



JJ-7-5203
18 cm



JJ-7-5204
Bruenings
19 cm

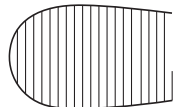
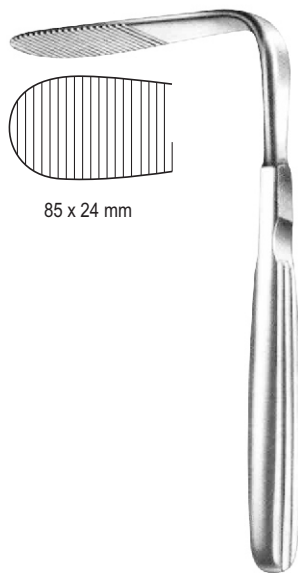

85 x 24 mm

JJ-7-5205
Tobold
15 cm

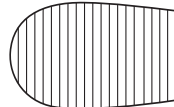
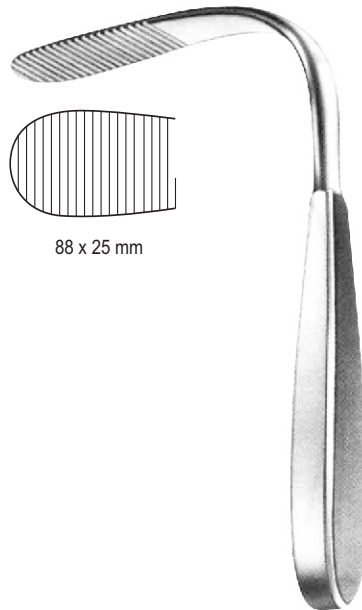

88 x 25 mm

JJ-7-5206
Tobold
16 cm

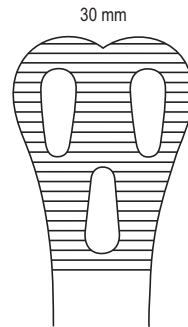

30 mm

JJ-7-5207
14 cm

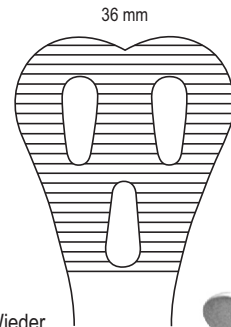

36 mm

JJ-7-5208
15 cm

Wieder

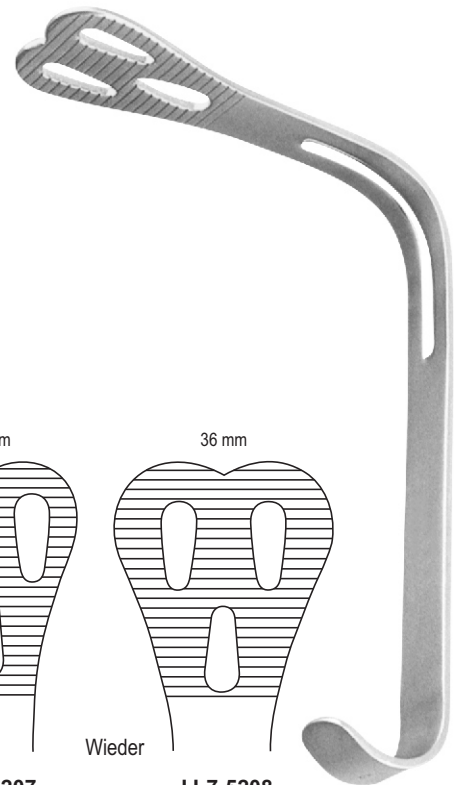

Lip and Cheek Retractors

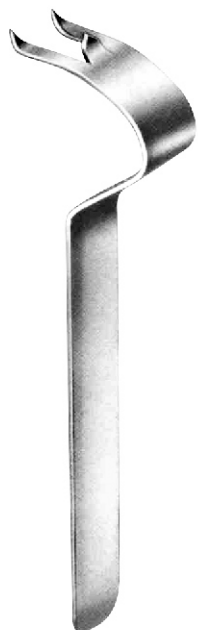

JJ-7-5209
Obwegeser Chin
Retractor
16.5 cm



Obwegeser 16 cm
JJ-7-5210 8 mm
JJ-7-5211 10 mm



JJ-7-5212 43 x 11 mm
JJ-7-5213 57 x 11 mm
JJ-7-5214 83 x 16 mm



35 x 11 mm

JJ-7-5215
Obwegeser
SpiAl-Alsatis retractor
22 cm



72 x 11 mm

JJ-7-5216
Obwegeser
Ramus retractor for
separation of ramus & tissue
22 cm



JJ-7-5217
Simplex
10.5 cm

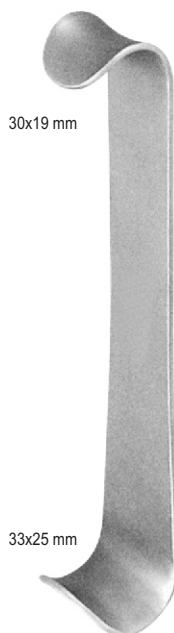

30x19 mm

33x25 mm

JJ-7-5218
Kilner
15 cm



JJ-7-5219
Minnesota
14 cm



JJ-7-5220
Cawood-Minnesota
15 cm



JJ-7-5221
Austin



JJ-7-5222
Hilger
Fits any simple stem mouth mirror handle



JJ-7-5223
Hilger
with handle

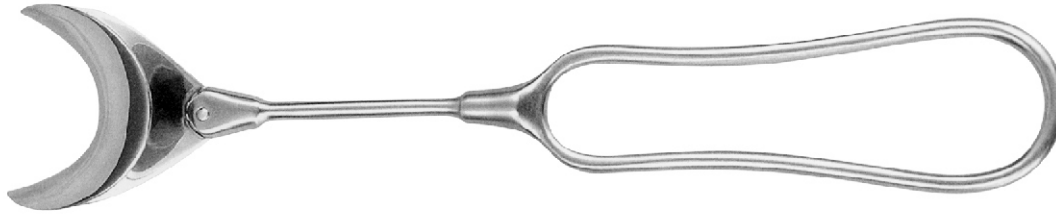

JJ-7-5224
Max
20 cm

Finger protectors



Langenbeck

JJ-7-5225 Small
JJ-7-5226 Medium
JJ-7-5227 Large

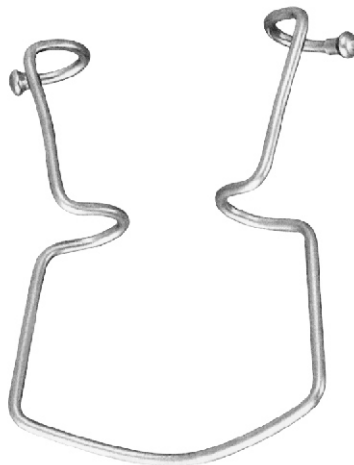

JJ-7-5228
Oringer
11.5 cm

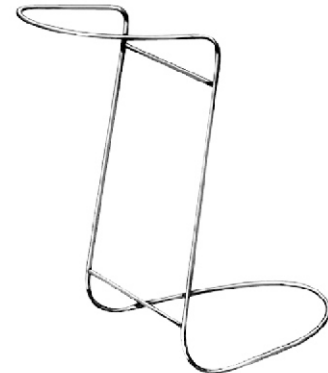

JJ-7-5229
Obwegeser Cheek Retractor
12cm

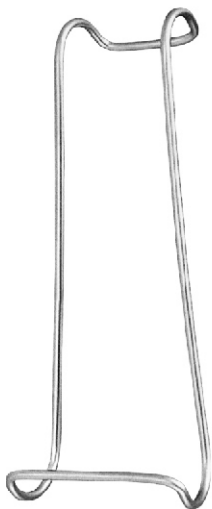

JJ-7-5230
Columbia
14.5 cm



Sternberg

JJ-7-5231 12 cm
JJ-7-5232 14 cm
JJ-7-5233 15 cm



Vestibulum
JJ-7-5234



JJ-7-5235
Max

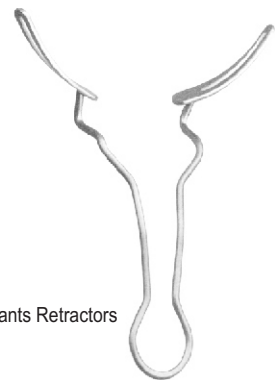

Implants Retractors

JJ-7-5236
Max

Retractors

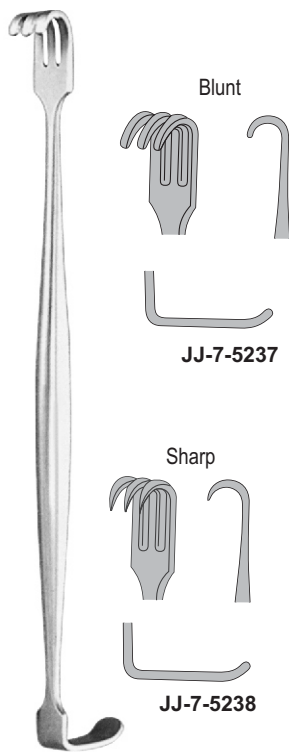

Blunt

JJ-7-5237

Sharp

JJ-7-5238

Senn-Miller
16 cm



Sharp

JJ-7-5239

JJ-7-5240

JJ-7-5241

JJ-7-5242

Max
16 cm

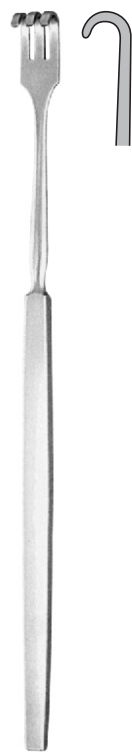

Blunt

JJ-7-5243

JJ-7-5244

JJ-7-5245

JJ-7-5246

Max
16 cm



Kirkland
Gum & Tissue
Retractors



JJ-7-5247
Fig. 23 K



JJ-7-5248
Fig. 24 K

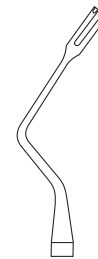

JJ-7-5249
Fig. 27 K



JJ-7-5250
Fig. 28 K



JJ-7-5251
Collin Tongue holding forceps
17 cm



JJ-7-5254
Rubber Pad pair

Young Tongue holding forceps
JJ-7-5252 15 cm
JJ-7-5253 17 cm

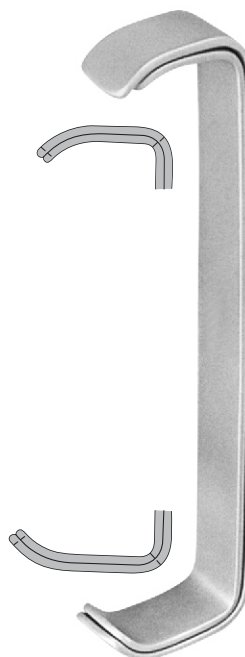

JJ-7-5255
Farabeuf 12 cm
Pair



JJ-7-5256
Parker-Langenbeck 21 cm
Pair

Osteotomes



15.5 cm

0	Ø 1.60
7.5	Ø 1.80
10	Ø 2.00
13.5	Ø 2.40
15.5	Ø 3.60

1
Ø 1.6 mm



JJ-7-5257
15.5 cm

# 2	Diam.
0	Ø 1.90
7.5	Ø 2.20
10	Ø 2.35
13.5	Ø 3.30
15.5	Ø 3.40
23.5	Ø 4.50

2
Ø 1.9 mm



JJ-7-5258
15.5 cm

# 3	Diam.
0	Ø 2.80
7.5	Ø 3.20
10.5	Ø 3.35
13.5	Ø 3.60
21	Ø 4.40

3
Ø 2.8 mm



JJ-7-5259
15.5 cm

# 4	Diam.
0	Ø 3.10
7.5	Ø 3.70
10.5	Ø 3.90
15.5	Ø 4.30

4
Ø 3.10 mm



JJ-7-5260
15.5 cm

# 5	Diam.
0	Ø 3.90
10	Ø 5.00
13	Ø 5.20
20.5	Ø 6.30

5
Ø 3.90 mm



JJ-7-5261
15.5 cm

# 6	Diam.
0	Ø 5.50
10	Ø 6.20
13	Ø 6.30

6
Ø 5.50 mm



JJ-7-5262
15.5 cm

# 1	Diam.
0	Ø 1.50
5	Ø 1.90
8	Ø 2.20
10	Ø 2.40
12	Ø 2.60
14	Ø 2.80

1
Ø 1.5 mm



JJ-7-5263
15.5 cm

# 2	Diam.
0	Ø 2.10
5	Ø 2.60
8	Ø 2.80
10	Ø 3.00
12	Ø 3.20
14	Ø 3.40

2
Ø 2.1 mm



JJ-7-5264
15.5 cm

# 3	Diam.
0	Ø 2.60
5	Ø 3.00
8	Ø 3.30
10	Ø 3.50
12	Ø 3.70
14	Ø 3.90

3
Ø 2.6 mm



JJ-7-5265
15.5 cm

# 4	Diam.
0	Ø 3.00
5	Ø 3.50
8	Ø 3.80
10	Ø 4.00
12	Ø 4.20
14	Ø 4.40

4
Ø 3.0 mm



JJ-7-5266
15.5 cm

# 5	Diam.
0	Ø 3.50
5	Ø 3.90
8	Ø 4.20
10	Ø 4.40
12	Ø 4.60
14	Ø 4.80

5
Ø 3.5 mm



JJ-7-5267
15.5 cm

Ø 2.8 mm



JJ-7-5268
15.5 cm

Ø 3.5 mm



JJ-7-5269
15.5 cm

Ø 4.2 mm



JJ-7-5270
15.5 cm

Spelling Straight
Bone Pusher

Implantology Instrumentns

Osteotomes

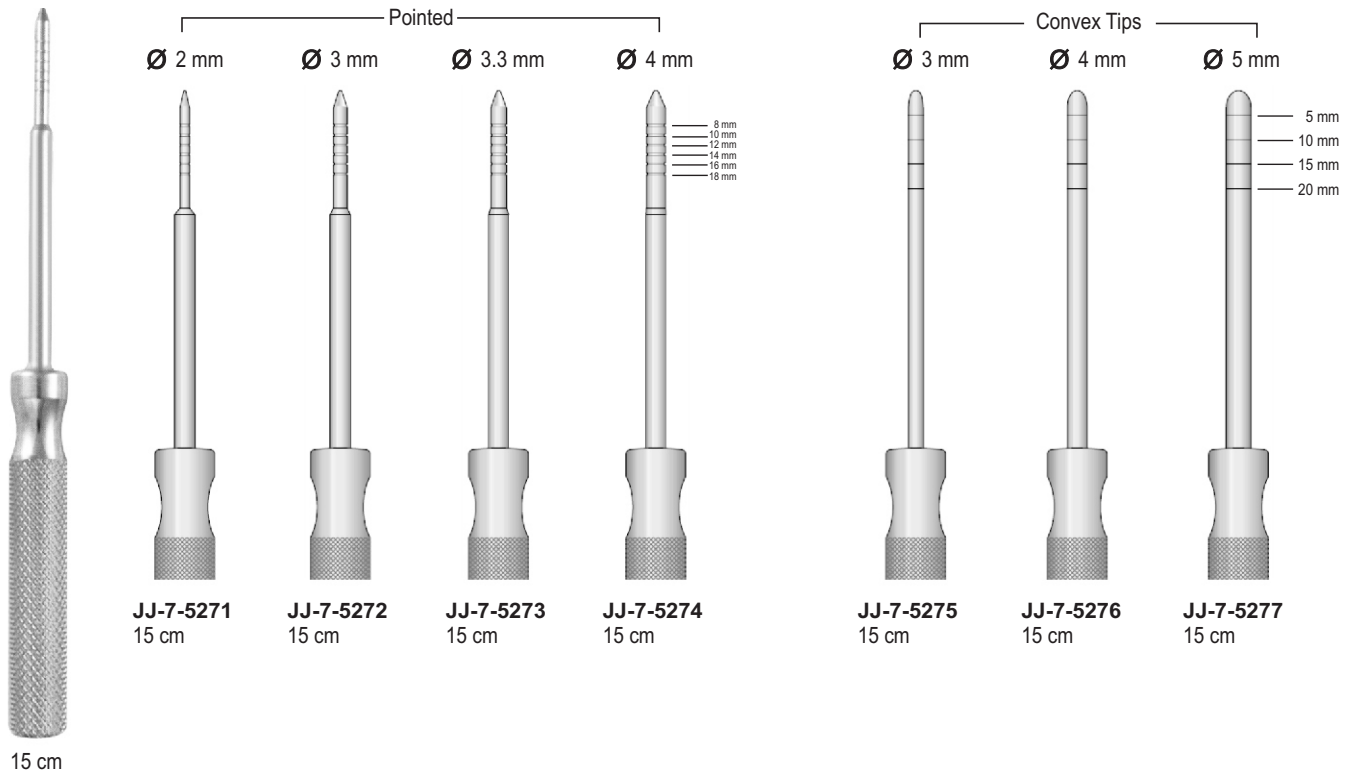

Convex Tips

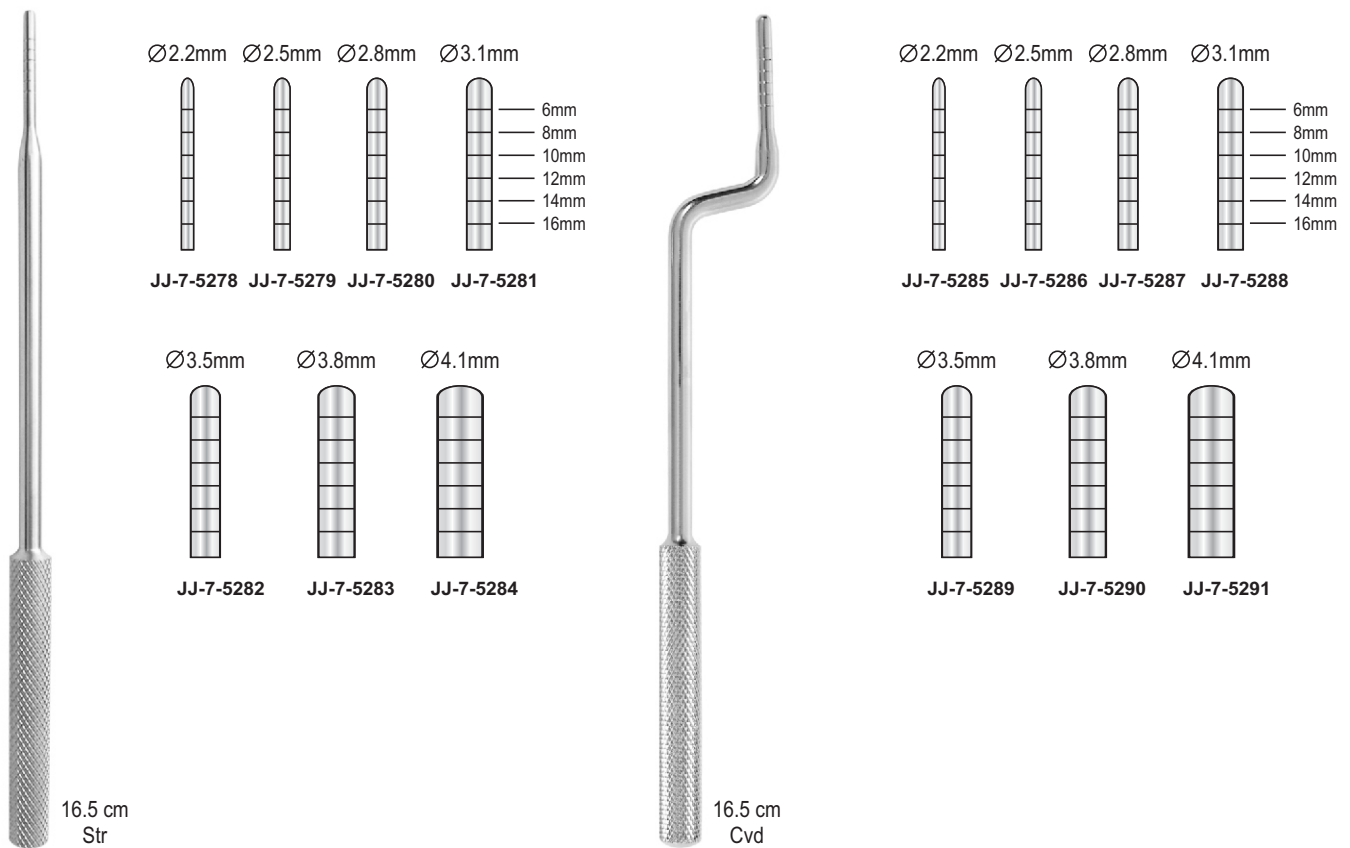

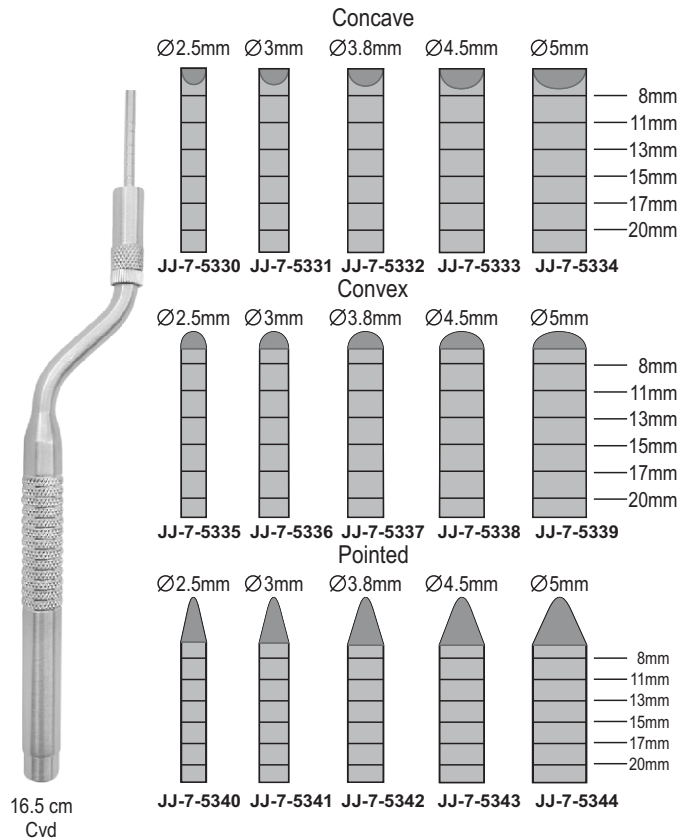
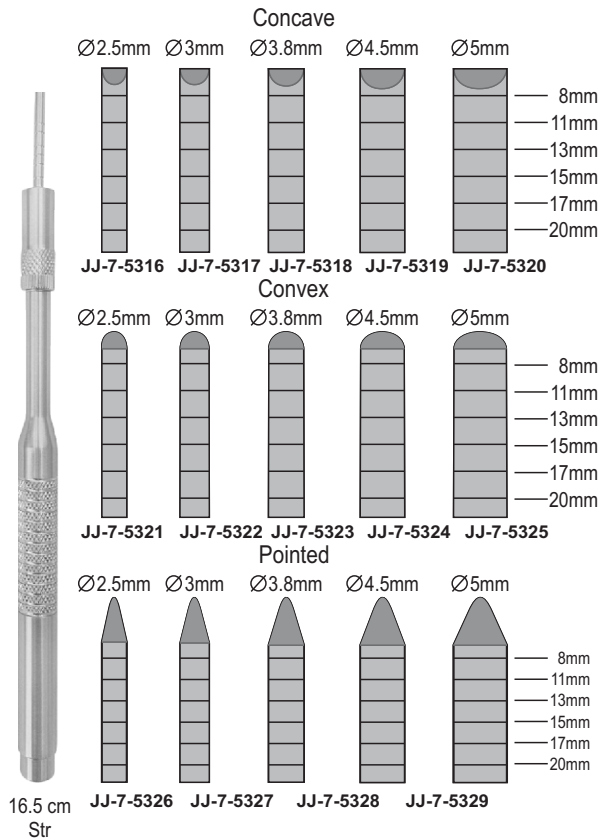
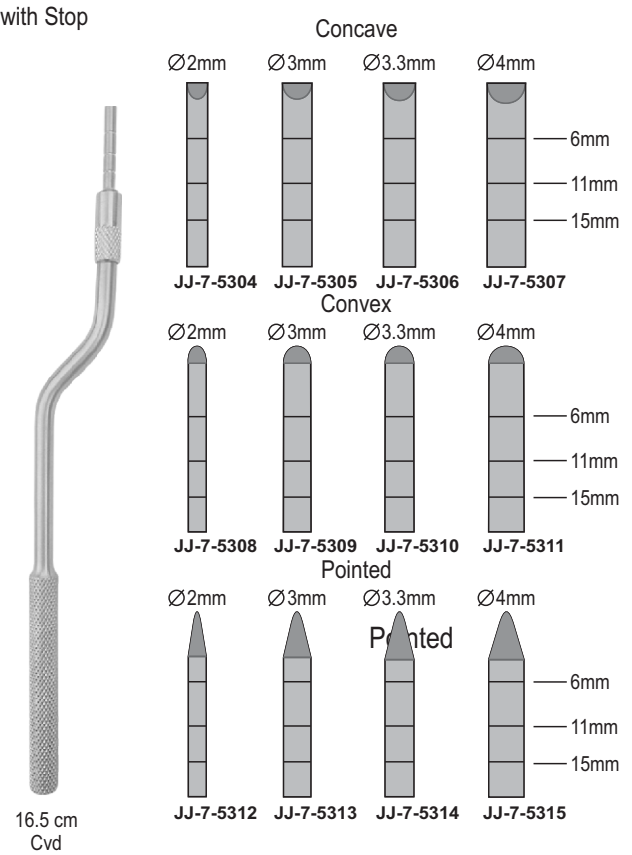
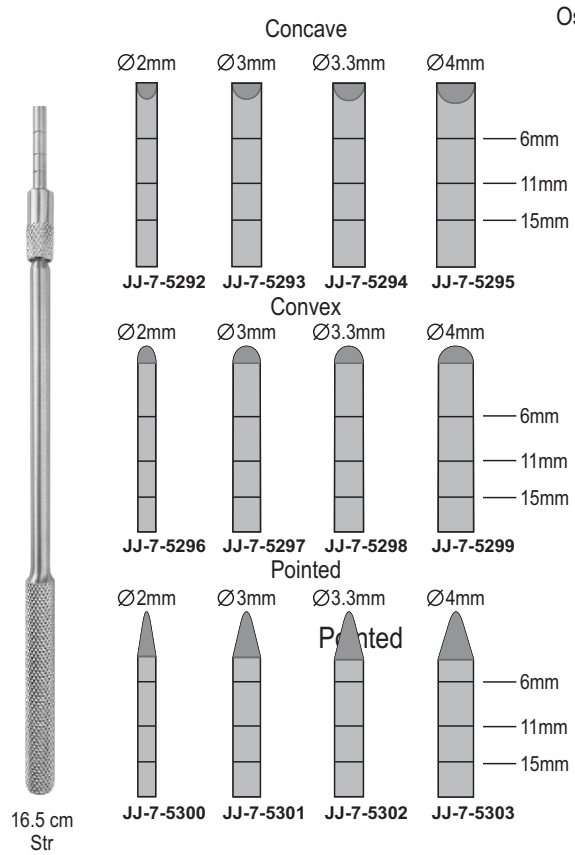

Implantology Instrumentns

PDL Elevators



JJ-7-5345 Distal, 2.5 mm Micro Edge



JJ-7-5346 Mesial, 2.5 mm Micro Edge

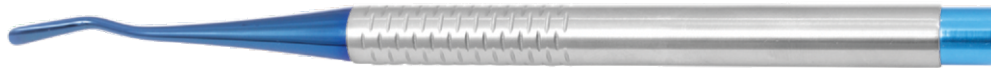

JJ-7-5347 Distal, 4 mm Micro Edge



JJ-7-5348 Mesial 4 mm Micro Edge

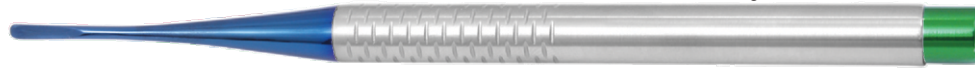

JJ-7-5349 2.5 mm Micro Edge, Straight



JJ-7-5350 2.5 mm Micro Edge, Curved



JJ-7-5351 3.4 mm Straight

JJ-7-5352 Set Of 7 Pieces



JJ-7-5353 Distal, 2.5 mm Micro Edge



JJ-7-5354 Mesial, 2.5 mm Micro Edge

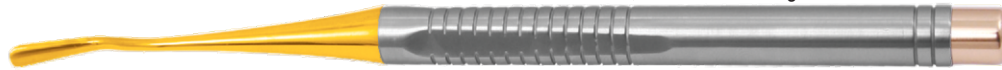

JJ-7-5355 Distal, 4 mm Micro Edge



JJ-7-5356 Mesial 4 mm Micro Edge



JJ-7-5357 2.5 mm Micro Edge, Straight



JJ-7-5358 2.5 mm Micro Edge, Curved



JJ-7-5359 3.4 mm Straight

JJ-7-5360 Set Of 7 Pieces



Instruments Tray

Trepine Drills



JJ-7-5361

Interior 2 mm
Exterior 3 mm

JJ-7-5362

Interior 3 mm
Exterior 4 mm

JJ-7-5363

Interior 4 mm
Exterior 5 mm

JJ-7-5364

Interior 5 mm
Exterior 6 mm

JJ-7-5365

Interior 6 mm
Exterior 7 mm

JJ-7-5366

Interior 7 mm
Exterior 8 mm

JJ-7-5367

Interior 8 mm
Exterior 9 mm

JJ-7-5368

Interior 9 mm
Exterior 10 mm



JJ-7-5369

Trepine Drills Stand
Complete with drills



JJ-7-5370

Trepine Drills Stand
Complete with drills

Tissue Punches



Keyes

JJ-7-5371
2 mm

JJ-7-5372
3 mm

JJ-7-5373
4 mm

JJ-7-5374
5 mm

JJ-7-5375
6 mm

JJ-7-5376
7 mm

JJ-7-5377
8 mm



Keyes

JJ-7-5378
3 mm

JJ-7-5379
4 mm

JJ-7-5380
5 mm

JJ-7-5381
6 mm

Implantology Instrumentns

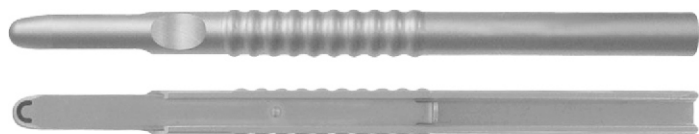

JJ-7-5382
Bone Collector Chisel Straight



JJ-7-5383
Blade for Straight bone collector chisel



JJ-7-5384
Bone Collector Chisel Curved



JJ-7-5385
Blade for Curved bone collector chisel



JJ-7-5386
Ratchet Screw driver handle
HexagoAll head

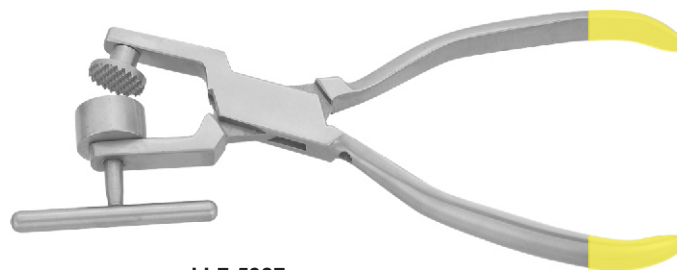

JJ-7-5387
Bone Morselizer with Titanium Grinding



JJ-7-5388
Bone Mixing Basin
Dia 35 mm



JJ-7-5389
Manual Easy Bone Mill



JJ-7-5390
Bone Craker Titanium

Page 152–155

- Impression Trays

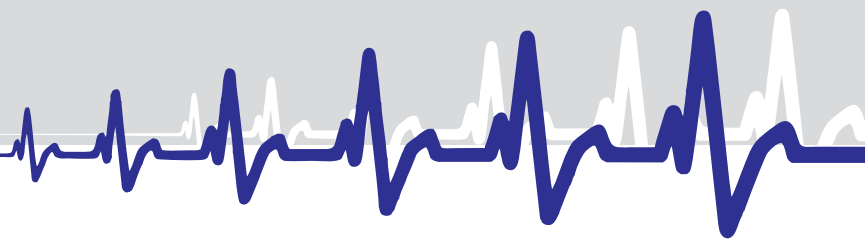

All Impression Trays Upper & Lower Type
are available in S, M, L & XL Sizes



JJ-7-5391
"HYDRO-LOCK"
stainless steel
water-cooled
impression trays
with retention rim.



JJ-7-5392
"HYDRO-LOCK"
stainless steel
water-cooled impression
trays with retention rim.



JJ-7-5393
"NEW SUPER"
stainless steel
impression trays
with retention rim.



JJ-7-5394
"NEW SUPER" stainless
steel impression trays
with retention rim.



JJ-7-5395
"AAITOMIC" solid
regular stainless
steel impression
trays without
retention rim.



JJ-7-5396
"AAITOMIC" solid regular
stainless steel impression
trays without retention rim.



JJ-7-5397
Perforated-total denture
stainless steel
impression trays with rim.



JJ-7-5398
Perforated-total denture
stainless steel
impression trays with rim.

Stainless Steel Impression Trays

All Impression Trays Upper & Lower Type are available in S, M, L & XL Sizes



JJ-7-5399
"PERMA-LOCK" solid regular stainless steel impression trays with retention rim.



JJ-7-5400
"PERMA-LOCK" solid regular stainless steel impression trays with retention rim.



JJ-7-5401



JJ-7-5402



JJ-7-5403



JJ-7-5404



JJ-7-5405



JJ-7-5406



JJ-7-5407
Set of six

PACKINGS



JJ-7-5408
Set of Eight



JJ-7-5409
Solid stainless steel anterior depressed impression trays with retention rim.



JJ-7-5410



JJ-7-5411



JJ-7-5412



JJ-7-5413



JJ-7-5414



JJ-7-5415



JJ-7-5416
Solid stainless steel anterior depressed impression trays with retention rim.

All Impression Trays Upper & Lower Type
are available in S, M, L & XL Sizes



JJ-7-5417
Fig. 0 per bambini - for children

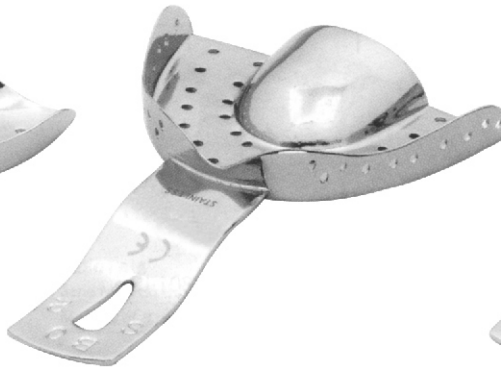

JJ-7-5418
For Alrow toothed upper jaws



JJ-7-5419
Fig. 0 per bambini - for children



JJ-7-5420
For partially toothed upper jaws



JJ-7-5421
For partially toothed lower jaws



JJ-7-5422
For edentulous upper jaws



JJ-7-5423
For edentulous lower jaws

Stainless Steel Impression Trays

All Impression Trays Upper & Lower Type are available in S, M, L & XL Sizes



JJ-7-5424
Solid total denture stainless steel impression tray with rim.



JJ-7-5425
Solid total denture stainless steel impression tray with rim.



JJ-7-5426
"PERMA-LOCK" perforated regular stainless steel impression trays with retention rim.



JJ-7-5427
"PERMA-LOCK" perforated regular stainless steel impression trays with retention rim.



JJ-7-5428
Perforated stainless steel anterior depressed impression trays with retention rim.



JJ-7-5429



JJ-7-5430



JJ-7-5431



JJ-7-5432



JJ-7-5433



JJ-7-5434



JJ-7-5435
Perforated stainless steel anterior depressed impression trays with retention rim.

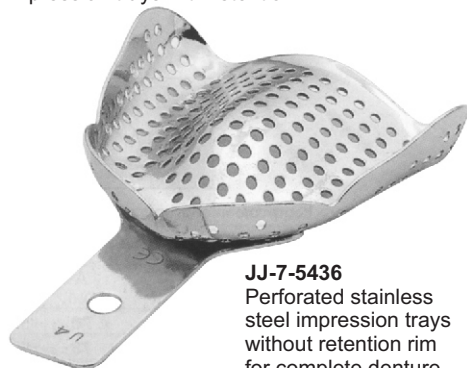

JJ-7-5436
Perforated stainless steel impression trays without retention rim for complete denture.



JJ-7-5437
Perforated stainless steel impression trays without retention rim for complete denture.

Page
156–157

- Arriculators

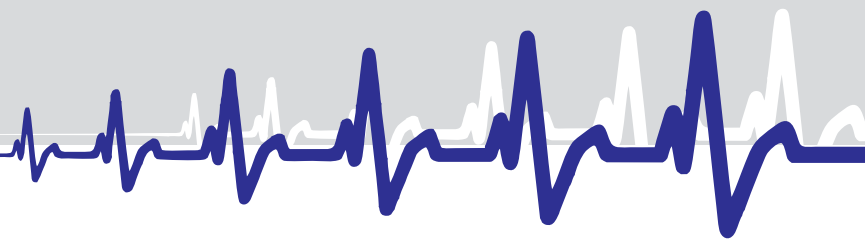

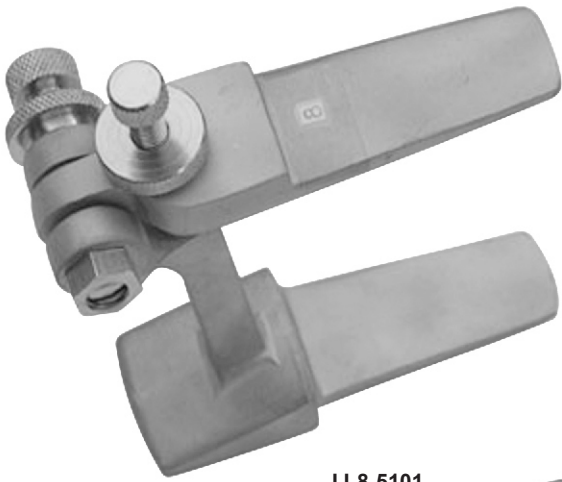

JJ-8-5101



JJ-8-5102



JJ-8-5103



JJ-8-5104

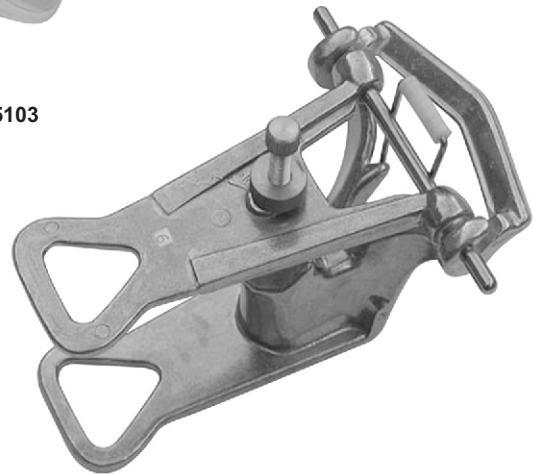

JJ-8-5105



JJ-8-5106

Articulators

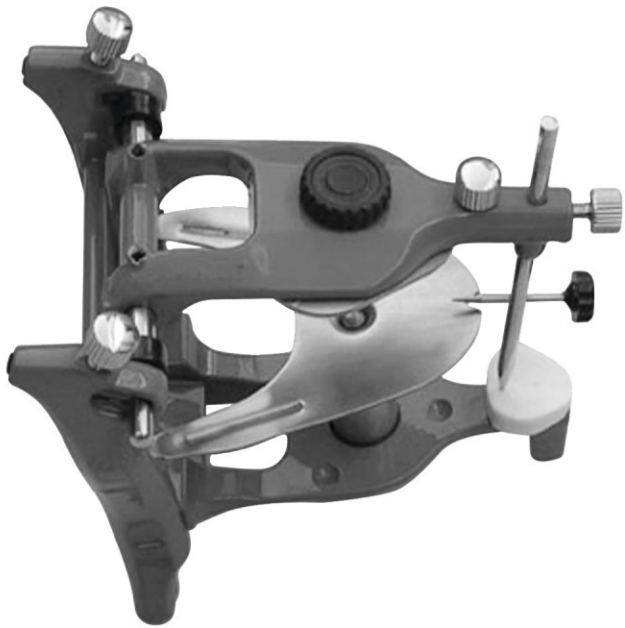

JJ-8-5107



JJ-8-5108



JJ-8-5109



JJ-8-5110

Page 158–160

- Dental Surgical Hollowares

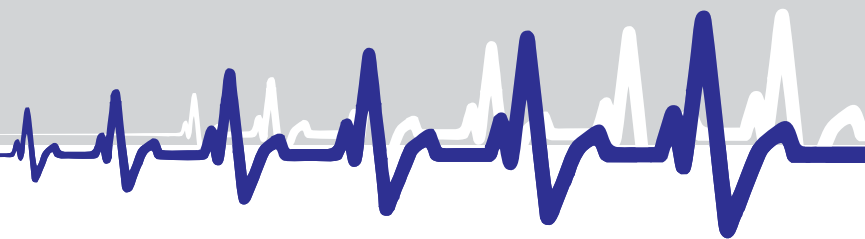

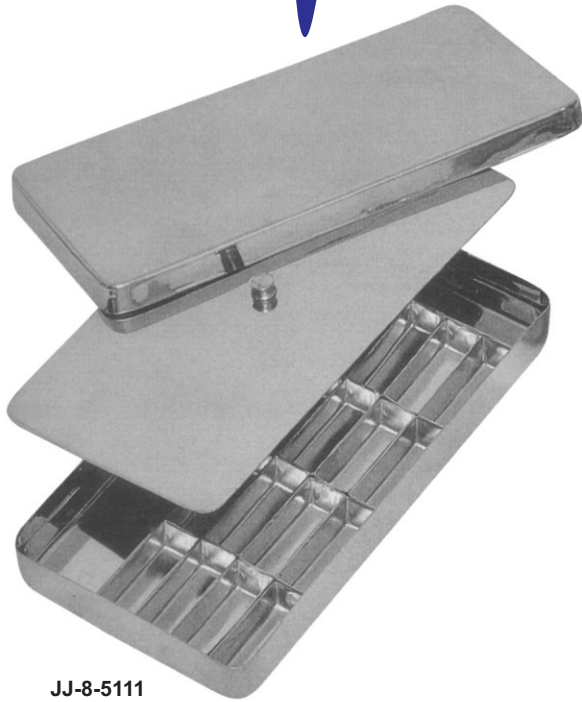

JJ-8-5111
ENDODONTIC BOX



JJ-8-5112
STERILIZING BOX
Available in dif. sizes
17x17x3 cm
20x10x4 cm
25x12x6 cm
30x14x6 cm



JJ-8-5113
ENDO TRAY BOX

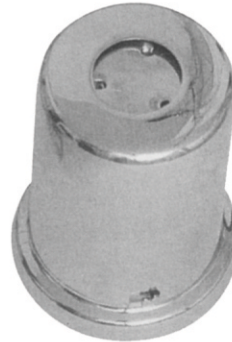

JJ-8-5114
COTTON DISPENSER

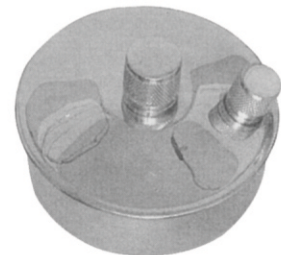

JJ-8-5115
ALCOHOL LAMP

Sterilizing Drums



JJ-8-5116



JJ-8-5117



JJ-8-5118

Dental & Surgical Hollowares

Sterilizing Boxes



JJ-8-5119



JJ-8-5120



JJ-8-5121

Sterilizing Boxes



JJ-8-5122



JJ-8-5123



JJ-8-5124



JJ-8-5125



JJ-8-5126



JJ-8-5127

FORCEP AND THERMOMETER JARS

COTTON DISPENSER



JJ-8-5128
IRRIGATOR(Douch can)



JJ-8-5129
MEASURING JUG



JJ-8-5130
KIDNEY TRAY



JJ-8-5131
FORCEP JAR

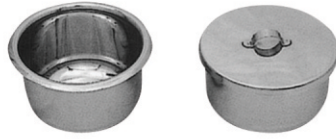

JJ-8-5132
GALLIPOT WITH & WITHOUT LID



JJ-8-5133
SPITTEN MUG



JJ-8-5134
SPIRIT LAMP

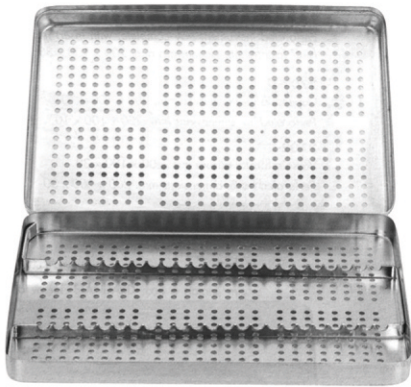

JJ-8-5135
Perforated Tray



JJ-8-5136
Perforated Base



JJ-8-5137
Solid Base



JJ-8-5138
Instruments Tray



JJ-8-5139
Instruments Tray



JJ-8-5140
**Instruments Tray
(Perforated)**



JJ-8-5141
**Instruments Tray Shallow
(Mayo)**



JJ-8-5142
Scalers Tray



JJ-8-5143
Cathetar Tray

Alphabetical Index

A		
Adams	125, 133	
Aderer	133	
Adson	96	
Ainsworth	110	
Albee	77	
Albrecht	109	
Alcohol Lamp	142	
AlgiAlte	93-94	
Allen	109	
Amalgam Carriers	117	
Amalgam Guns	117	
Amalgam Well	117	
Andresen	134	
Angle	133	
Antkoviak	78	
Apical	36, 44	
Arruga	97	
Articulators	140	
Ash	53, 88	
Aspirating Syringes	102	
B		
Band Adaptor	102	
Barry	47, 50	
Baumgarthner	96	
Beale	76	
Beebee	116	
Bein	33, 40	
Bennet	53, 123	
Beyer	121	
Bicuspids	114	
Birdbeak Pliers	132	
Blumenthal	120, 121	
Bohler	120	
Bohm	118	
Boley	77	
Bone Chisels	68	
Boynton	97	
Breech Loading Syringe	102	
Brewer	110	
Buck	61-63, 65	
Buckley	67, 124	
Burnishers	58	
C		
Caroll	77	
Castroviejo	77, 98, 100	
Cathetar Tray	144	
Cement Spatulas	91, 92	
Chompret	44	
Ck1	108	
CK2	108	
Cleveland	122	
College	105, 107	
Columbia	64, 66, 74	
Columbia	79	
Cone-Socket	90	
Cork Screw Tip	104	
Cotton Dispenser	142, 143	
Coupland	37	
Crane-kaplan	74	
Crile-Wood	96	
Crown Removers	115-116	
Cryer	35, 37, 48	
Curette	64, 66	
D		
De La Rosa	129	
Dental Probes	57	
Dental Syringes	103-104	
Derf	95	
Didner	113	
E		
Eliselberg-Mathieu	97	
Eliott	53	
Endo Finger Ruler	102	
Endo Tray Box	142	
Endodontic Box	142	
Ermert	78	
Excavators	87-88	
Explorers	81	
Extracting Forceps	01-31	
F		
Fahnenstock	79	
Filling Instruments	52-56	
Fischer	134	
Flagg	107	
Flohr	38	
Forcepps Jar	143, 144	
Fox	58	
Fraizer	100	
Freer	123	
Friedman	119-120	
Furrer	119	
G		
Gallipot	144	
Gardner	67, 122	
GF1	108	
GF2	108	
Gillies	96	
Goldman Fox	60, 63, 65, 73, 120	
Goslee	134	
Gouges	68	
Gracey Curettes	69	
Gracey Mesial Distal	69	
Gracey	56-69-72	
Gritman	76-78-80	
H		
Halstead-Mosquito	118	
Hegar-Baumgartner	95-96	
Heidbrink	45-48-50	
Heidemann	55	
Hemingway	75	
HeAlhan	123	
How	133	
Hylin	40, 76	
I		
Impression Trays	136-139	
Intra-Ligamental Syringes	104	
Irrigator	143	
Ivory	110, 113	
Iwanson	77	
J		
Jaquette	74	
Johnson	133	
K		
Kelly	118	
Kerrison	120	
Kidney Tray	143	
Kilian	124	
Kilian-Claus	124	
Klein	07	
Kleinert-Kutz	121	
Kopp	39, 49, 108	
L		
Landgraf	107	
Langenbeck	134	
Le Cron	76	
Lecluse	43	
Lessmann	79	
Lichtenberg	97	
Listion-mini	122	
London Hospital	41	
London-College	107, 109	
Lucas	75	
Luer	120	
Luks	84	

M			Rhodium			W		
Machtou	83		Roach	76	Wake eld			
Mallets	68		Root Elevators	32--51	Waldron	67		
Mathieu	99, 100		Root Splinter	31	Waldsachs	133		
Matrix Bands	113, 114		Root-CaAll Excavators	86	Warwick-James	130, 133		
Matrix Retainers	113		Root-CaAll Explorers	86	Water Syringe	41		
Mayo-Hegar	95		Root-CaAll Plungers	84-85	Weingart	101		
Mc Call	73		Rubber Dam Clamps	111-112	White	129, 133		
Mc Kellops	133		Rubber Dam Frame	110	Williams	52, 60, 83		
Mead	43, 58, 119		Ruskin-Mini	121	Williger	123		
Measuring Jug	143				Winter	46, 50		
Measuring Plate	84				Woodson	54, 55		
Medicon	78		S					
Meriam	106, 109		Scalers	58				
Merrit A	60		Schell	119				
Mershon	110, 116		Schilder	85				
Micro-Barraquer	99-100		Schluger	61, 62				
Micro-Mosquito	118		Schwarz	134				
Miller	118, 124		Seldin	34, 48, 123				
Mini-Ryder	95		Spirit Lamp	144				
Molar	114		Spitten Mug	144				
Morell	116		Spreader	82-83				
Mouth Mirror Handles	89, 90		Sterilizing Boxes	142, 143				
Mouth Mirrors	89, 90		Sterilizing Drums	142				
MSY	76, 134		Sugarman	61, 162				
N			T			Y		
Albers	83		Taylor	74	Young	133		
Alnce	128, 133		Toennis	97	Younger-Good	73		
Niro	122		Tof emire	114				
			Tof emire-Junior	113				
O			Tof emire-Senior	113				
Obwegeser	124		Tof emire-Universal	113				
Ochsenbein	61, 62, 67		Towner Jaquette	74				
Olsen-Heger	96		Towner	74				
Oms	83		Trays	144				
Ott	41		Treyman	116				
			Tweed	130				
P								
P.K. Thomas	76		U					
P.K. Thomas	68		Univarsal "HM"	116				
Partsch	134		Univarsal	128, 133				
Pocket Probes	58-60		University of Michigan	60				
Plaster Knives	80		USA Model	133				
Plaster Spatulas	93-94							
Position Gauge	102							
Pott	42							
R			V					
Rein	81		Vehe	76				
Relax	05		Vernier	77				
Reynolds	129		Vertical Condenser	83				
Rhodes	61, 62							



Jordi & Jamil Instruments

 MachiKhokhar, Marala road,
Sialkot, 51310, Pakistan.

 +92 328 615 6070

 info@jjordiinst.com

 www.jjordiinst.com



Our Certifications:

ISO 9001	ISO 7151
CE Certified	ISO 17664:2004
EN 13485:2012	ISO 13402
ISO 7153-1	ISO 15223